

# GRANULE SMART®

HIGH CAPACITY IN A SMALL SPACE.





# PURE POWER.

In a professional kitchen, you can't spend too much time washing up. Granule pot washing machines from GRANULDISK of Sweden gives you access to innovative, powerful technology to streamline pot washing. More emphasis on food – fewer resources for getting your pots clean.

Traditional pot washing has always been a laborious, resource-intensive task in any production kitchen. GRANULDISK technology has turned things on their head and revolutionised washing-up areas by making hard work easy. Our PowerGranules® blast the pots clean mechanically using high-pressure water and a small amount of chemical. Even stubborn food debris is removed with ease, and this technology saves energy, time and money while also reducing environmental impact and improving the work environment.

Manual pot washing requires soaking, scrubbing and sinks full of water. The GRANULDISK concept represents something completely different. Our pot washing machines take care of the entire job, thus eliminating the need for pre-washing. We refer to this concept quite simply as "No Pre-Washing". In just a few minutes, your pots are both visibly and hygienically clean thanks to a power similar to the efficiency of thousands of people washing by hand. The overall result is a more productive washing-up area and less of the things which cost money and impact upon the environment.



# SAY YES TO NO PREWASHING.



No soaking required.



No scrubbing required.



No prewashing. PowerGranules® eliminate the need for pre-washing. All you have to do is scrape the dishes, press the button and let the dishwasher do its job.



From dirty to clean in just 2 minutes with the help of PowerGranules®, water and a small amount of chemical.



Potwashing is a job which often involves burnt or dried-on food. Achieving good, fast results requires an outstanding washing method. When our PowerGranules® are set in motion in the machines, it's as though thousands of people are washing the pots by hand in terms of power and efficiency. Used together with high-pressure water

and a small amount of chemical, our PowerGranules® achieve mechanical cleaning of anything coming out of the professional kitchen. Even stubborn food can be removed with ease, and every time a washing programme ends there's just one thing left – dishes which are both visibly and hygienically clean.



## GRANULE SMART®

Small, smart and high-performance – Granule Smart® has everything, and is particularly well suited to kitchens which have to make the most of the space available.

Every space is valuable in the modern kitchen, and so as much space as possible has to be used for serving customers. Granule Smart® is a very compact machine which saves space and takes up less than 1 m<sup>2</sup>. The smart design of this machine is clear from the fact that the hatch opens out and acts as an integrated loading and unloading table. It also comes with a built-in basket lift which makes it easy to pull out the basket and improve ergonomics.

Even though the Granule Smart® is compact and saves space, it still offers high capacity. This machine is capable of handling up to 180 GN 1/1 per hour and is suitable for producing up to 1 000 meals a day. The entire GN range – GN 1/1 and the range of small containers – can be loaded into the basket, and a simple accessory also allows GN 2/1, grill racks, chopping boards, etc. to be loaded easily. It is also possible to wash pots, bowls and pans.



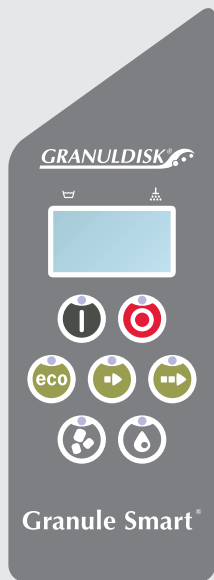

## CONTROL PANEL.

User-friendliness is always a key focus for our control panels and the display, symbols and messages are easy to understand, making it easy to select the correct wash programme. Choose with or without PowerGranules and programme lengths Eco, Short or Normal. When the machine is in use the red indicator is lit and the display changes into a countdown timer, showing the remaining time in large digits.

Wash and rinse tank temperatures are shown in the display at all times and with a simple command, you can view HACCP data for up to 200 of the previous wash programmes.

Integrated function GD Memo™ uses the control panel display for automatic reminders regarding change of PowerGranules®, wash water and when to book a service appointment.



*The coloured indicators make it easy to see whether the machine is working (red) or ready for loading or unloading of pots (green).*

## HACCP LOG.

The operating system in GRANULDISK pot washers logs all HACCP-essential information for up to 200 wash cycles through the built-in HACCP Log feature.

The data - containing valuable information such as wash/rinse water temperatures, programme lengths, interruptions and alerts - is easy to follow up on and helps you ensure that your pot wash operation always complies with HACCP protocol.

The data is easily accessed and viewed directly via the display in the control panel or downloaded to a USB stick through a built in USB port. The flexible .txt file format can be stored as is, or easily be imported to various computer programmes, to for example add it to your HACCP reports.



## ECOEXCHANGER®

The optional add-on EcoExchanger offers steam reduction and heat recovery built into one. Thanks to clever design it only builds 230 mm on top, keeping the total install height low. The efficient steam reduction feature captures the vapor from the wash cycle and reduces the amount of steam released into the room after completed programme.



The heat recovery feature recycles heat energy from the vapor and uses it to heat up incoming rinse water, resulting in up to 40% lower energy consumption for heating the rinse tank. For more information, please see separate product sheet.

## POWERGRANULES®

PowerGranules® are specially designed for use with GRANULDISK products.

PowerGranules® are made from a plastic which has been tested and approved for contact with food. The unique mix of sizes and the composition of the material gives an exceptional removal rate.



10 litres | Art no. 22633    20 litres | Art no. 22634

## MAINTENANCE.

Daily cleaning is every bit as important as regular servicing to ensure optimal wash results, simple and worry-free operations and in the long run extend the service life of your machine.

We guarantee spare part availability for at least 10 years after a model has been taken out of production. Make sure any servicing or maintenance is carried out by a Certified GRANULDISK Partner.

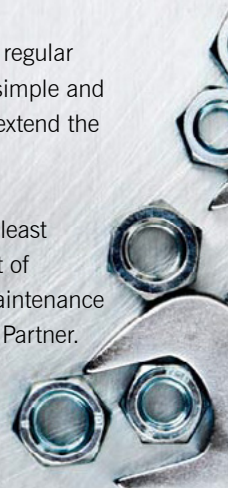

## TECHNICAL DATA.

Design	With integrated loading table (the hatch opens out to form a table)
Outer dimensions	2034 (± 25) x 1024 x 1315 mm (H x W x D) open
Loading volume	220 litres (ø 700 mm x H 570 mm)
Weight	381 kg (filled machine) 257 kg (empty machine)
Wash tank volume	108 litres
Granule volume	8 litres
Wash water temperature	65 °C
Rinse water temperature	85 °C
Wash programmes with Granules	ECO: 2 min Short: 3 min*** Normal: 5 min***
Wash programmes without Granules	ECO: 2 min Short: 2 min, 30 sec*** Normal: 4 min, 30 sec***
Max capacity per hour	180 GN1/1 or similar in other pots.
Normal capacity per hour	144 GN1/1 or similar in other pots.
Capacity per programme	6 GN1/1 65 mm depth or 3 GN1/1 up to 200 mm depth and 3 GN1/1 up to 65 mm depth, or similar in other pots.
Rinse water volume	4 litres/ECO programme 6 litres/Short and Normal programmes To achieve 3600 HUE in accordance with NSF/ANSI 3, 6 litres is necessary.
Available voltage**	3~ 400 V/50 Hz + PE 3~ 415 V/50 Hz + PE 3~ 230 V/50 Hz + PE
Fuses, hot water connection	25A (400V, 415V), 40A (230V)
Fuses, cold water connection	32A (400V, 415V)
Max output, hot water connection	11,5 kW
Max output, cold water connection	16,5 kW
Wash pump motor	2,2 kW
Rinse pump motor	0,11 kW
Wash tank element*	9 kW, (14 kW (cold water connection))
Rinse tank element*	9 kW, (14 kW cold water connection)
Enclosure rating	IPX5
Sound pressure level	<70 dB(A)
Hot water	½" (DN15), 55–65 °C, 3–10 °dH Note: Reverse osmosis water and distilled water must not be used.
Water pressure/flow hot water	1–6 bar, 15 litres per minute
Cold water	½" (DN15), 3–10 °dH
Water pressure/flow cold water	1–6 bar, 15 litres per minute. With optional steam reduction; 3–6 bar
Recommended ventilation capacity	500 m³/h (without steam reduction) 150 m³/h (with steam reduction)
Drainage pipe	Pipe ø 32 mm
Drain	Capacity requirement 50 l/min The machine must not be placed directly over a drain.
Detergent and drying agent are required	Detergent and drying agent; 230 VAC signal is available from a separate box. Max load total 0.5 A.

\* Does not operate simultaneously

\*\* For specific data on machines supplied, please see the rating plate on the machine.

\*\*\* 30 sec longer with steam reduction.

Granule Smart® is supplied with a power cable 2 metres long (without a plug) for connection to an approved main switch. The main switch is not included in the delivery.



### HIGH CAPACITY.

Washes 6 GN1/1 per programme.  
Up to 180 GN1/1 or GN1/2 per hour  
(containers up to 65 mm deep).



### TIME-SAVING.

Clean pots and pans from 2  
minutes - no pre-washing needed.



### WATER-SAVING.

The ECO programme saves up to 2 200  
litres per day and up to 660 000 litres per  
year compared with manual washing-up  
in sinks (800 meals per day, 300 days  
per year).



### SAVING ON CHEMICALS.

Saves up to 4.5 litres per day and up  
to 1350 litres per year compared with  
manual washing-up in sinks (800  
meals per day, 300 days per year).



### FOOD SAFETY.

All programmes of the Granule Smart®  
pot and pan washer comply with  
the hygiene guidelines of the  
DIN 10512 standard.



# ACCESSORIES.

Granule Smart comes with a carefully selected accessory package to fit the standard operation - further customise and enhance it by adding one or more additional accessories.

For loading options and full range of available accessories, please visit [www.granuldisk.com](http://www.granuldisk.com)



[www.granuldisk.com/granule-smart-accessories](http://www.granuldisk.com/granule-smart-accessories)



## STANDARD DELIVERY GRANULE SMART®.

Standard delivery of Granule Smart® includes one Granule Smart pot washer and the below accessories.



### GRANULE SMART®

Machine including USB port for HACCP Log, GD Memo™, type AB air gap according to EN1717.

#### Standard delivery:

- 1 pc 19999 Standard wash basket
- 1 pc 21838 Scraper
- 1 pc Granule collector 8 litres
- 8 litres PowerGranules® (in the machine)

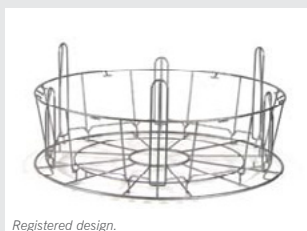

*Registered design.*

### STANDARD WASH BASKET.

**ART NO. 19999**

Capacity: 6 GN 1/1 65 mm or 3 GN 1/1 up to 200 mm + 3 GN 1/1 up to 65 mm. Equipped with small hooks which enables up to 12 small containers (1/4, 1/6, 1/9) to be loaded directly into the wash basket.



### SCRAPER.

**ART NO. 21838**

For pre scraping.



### GRANULE COLLECTOR.

**ART NO. 21550**



## ADDITIONAL ACCESSORIES.

Each of the accessories included in standard delivery are also available for single order, as well as an additional range of other useful accessories. What are your wash needs?

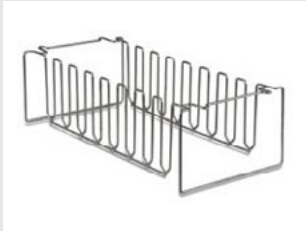

### INSERT FOR TRAYS.

**ART NO. 19992**

To be placed inside standard wash basket (19999). Holds 2 GN 2/1 or, 6 baking trays 600x400 mm up to 20 mm edge and 2 GN 1/1 sized trays, up to 16 grids, up to 8 chopping boards and GN 1/1 lids.



### MULTIFLEX HOLDER FOR SAUCEPANS, SMALL BOWLS, SIEVES.

**ART NO. 20554**

To be placed inside standard wash basket (19999). Capacity: up to 3-4 saucepans or up to 4-5 small bowls, sieves etc.



### HOLDER FOR BOWLS & POTS WITH INTEGRATED LADLE HOLDER.

**ART NO. 13756**

To be placed inside standard wash basket (19999). Capacity: up to 5-6 bowls or pots. Height of ladles up to 500 mm.



### FLEXIBLE POT HOLDER.

**ART NO. 13789**

Rubber strap with two hooks. Rubber strap to be placed around pot and hooked on to the basket.



### POT BASKET.

**ART NO. 21423**

Holds 2 large pots (200 mm) or 1 large pot (400 mm). Placed in machine instead of Standard wash basket.



### HOLDER FOR STORAGE OF ACCESSORIES.

**ART NO. 6001159**

To store inserts and accessories not in use. Hung at either side of the machine.



## MARINE OPTION.

Selecting the Marine Option customises Granule Smart® for use off shore, for example on board ships and oil rigs. While at sea, the twin level sensors fitted in the wash tank help to prevent repeated alarms which may interrupt the workflow. The “marine feet” are secured to the floor to prevent the machine tipping over. This machine is also readily accessible for servicing as no servicing is carried out from the rear.

Marine Option provides a stable, reliable and safe potwashing solution for marine installations.



[www.granuldisk.com/marine-edition](http://www.granuldisk.com/marine-edition)

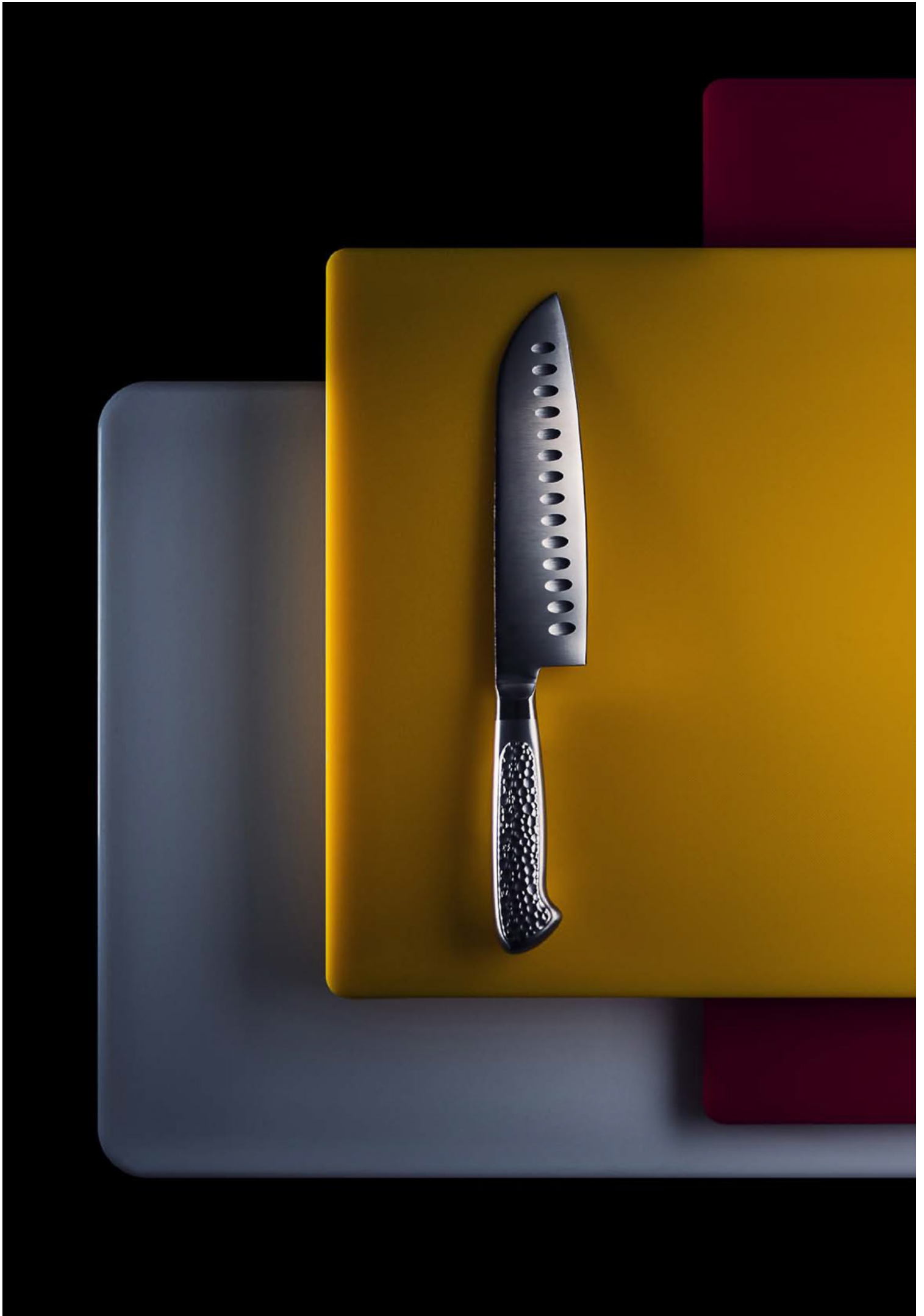



# INSTALLATION.

**A** = Water supply: 55–65 °C (cold water optional), 3–10 °dH, 5–18 °f.

1–6 bar, 15 L/min, max 6 bar static.

G ½" BSP female, flexible hose min inner ø 9 mm.

**B, E** = Detergent/drying agent connection, signal 230V AC.

**C** = Electrical connection (technical data on page 8 or in user manual).

**D** = Drain ø 32 mm, capacity min 50 L/min.

**F** = Cold water supply (in case of optional integrated steam reduction or EcoExchanger unit).

## Other:

Ventilation capacity: With steam reduction 150 m³/h (requires separate cold water connection, 3–6 bar (F)). Without steam reduction 500 m³/h.

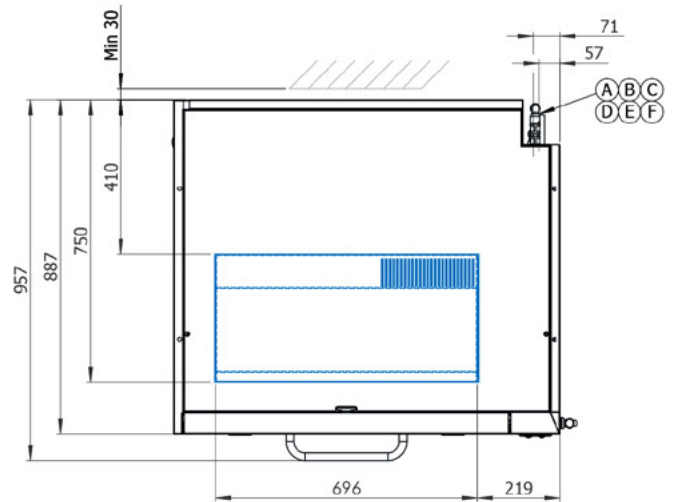

### EcoExchanger unit (optional add-on)

The EcoExchanger unit (heat recovery and steam reduction) must be connected to cold water feed at all times. (F)

Note: EcoExchanger is only available for cold water option machines (max power 32A, 16,5 kW) but on site, the machine can be connected to either hot or cold water feed. (A)

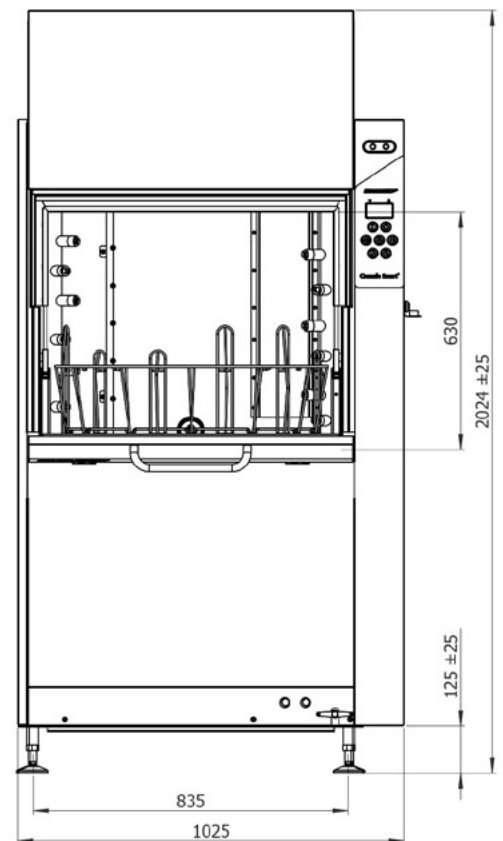
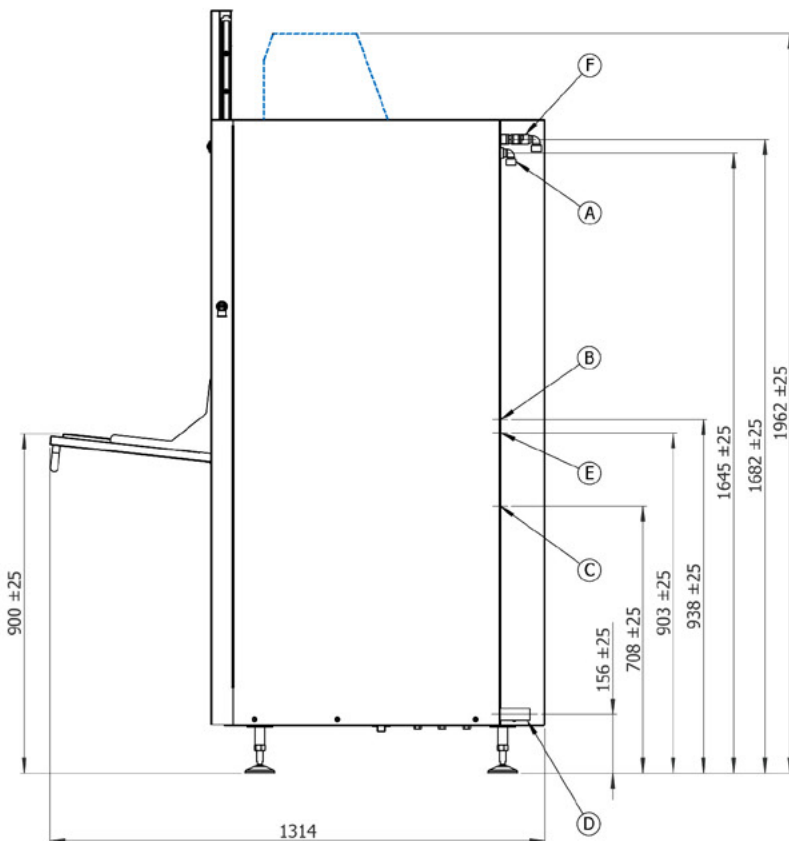

# GRANULDISK®

**FSM** (FOOD SERVICE MACHINERY PTY. LTD.)

### HEAD OFFICE:

21-23 Agosta Drive, Laverton North,  
Vic. 3026 Australia  
T: +61 3 9368 2300 F: +61 3 9369 3800  
E: sales@fsm-pl.com.au W: www.fsm-pl.com.au

### SYDNEY OFFICE:

Unit 15, 7-9 Progress Circuit,  
Prestons, NSW 2170  
T: +61 2 9608 8620 F: +61 2 9607 9370  
E: sales@fsm-pl.com.au W: www.fsm-pl.com.au

### QUEENSLAND OFFICE:

4/40 Rivergate Place,  
Murarie, QLD 4172  
T: +61 7 3390 4185 F: +61 7 3393 9508  
E: sales@fsm-pl.com.au W: www.fsm-pl.com.au

### PERTH:

T: 0413 893 311  
E: sales@fsm-pl.com.au  
W: www.fsm-pl.com.au