



Excellence since 1976



RICE COOKERS



BOX, WIRE & PLASTIC MATT SHELVING



KITCHEN VENTILATION



COMMERCIAL MICROWAVES



FOODSERVICE PRODUCTS



FOOD HOLDING SOLUTIONS



CREATORS OF THE BLENDER



CAN OPENERS



HOT & COLD FOOD SERVING SYSTEMS



DRINK & GRANITA MACHINES



MICROWAVES



LEADERS IN FOOD WARMING & HOLDING



SPACE SAVING PLATE STACKERS



NEW GENERATION TAPWARE



FOOD PROCESSING & HOLDING



CONTACT GRILLS



FOOD SERVICE, SAFETY & DISPENSING



DROP IN FREEZER



WINE STORAGE SOLUTIONS



THE ONLY IN-FRYER FILTER SYSTEM



QUALITY INDUCTION COOKING



MIXERS - COMMERCIAL



KITCHEN ACCESSORIES



ELECTRIC CHARGRILLS



*Excellence since 1976*

*Welcome to our Catalogue / Price List*

## **KEY CONTACT LIST**

### **VICTORIA - HEAD OFFICE**

Sales & Administration  
21-23 Agosta Drive, Laverton North, Victoria 3026  
(03) 9368 2300  
sales@fsm-pl.com.au www.fsm-pl.com.au

### **FOR SERVICE / WARRANTY REQUIREMENTS**

Book a SERVICE at  
<https://fsm-pl.com.au/book-a-service/>

### **FOR ALL SPARE PARTS REQUIREMENTS**

spares@fsm-pl.com.au  
(03) 9368 2300

Dedicated local representatives ready to assist in:

**MELBOURNE | SYDNEY | BRISBANE | PERTH | AUCKLAND**

**Visit our web site  
[www.fsm-pl.com.au](http://www.fsm-pl.com.au)**

**for updates, the latest products, downloads and sales contacts.**



# CONTENTS

|   |              |   |               |
|---|--------------|---|---------------|
| <b>ASAHI</b>  | <b>9</b>     | <b>ECOFAST WASTE MANAGMENT</b>              | <b>75</b>     |
| Rice Cookers  | 9            | <b>NEW</b> Waste Station                    | 75            |
| <b>ATLAS</b>  | <b>10-17</b> | <b>NEW</b> Food Waste Disposal Unit         | 75            |
| Verde Box Kits  | 10           | <b>EDLUND CAN OPENERS</b>                   | <b>76-77</b>  |
| Wire 4 Tier Shelving Bays & Add-On Kits               | 11-12        | Manual & Electric Can Openers               | 76            |
| Wire 5 Tier Shelving Bays & Add-On Kits               | 13           | Sanitation & Storage                        | 77            |
| Wire Single Shelves                                   | 14           | <b>EMAINOX</b>                              | <b>78</b>     |
| Plastic Mat 4 Tier Shelving Bays & Add-On Kits        | 15           | Drop In Refrigerated Wells                  | 78            |
| Plastic Mat 5 Tier Shelving Bays & Add-On Kits        | 16           | Drop In Heated Ceramic Glass Hotplate       | 78            |
| Plastic Mat Single Shelves                            | 17           | <b>GBG MACHINES &amp; WHITTY SYRUPS</b>     | <b>79-82</b>  |
| <b>AUSTREAM KITCHEN VENTILATION</b>                   | <b>18-21</b> | GBG Granita Machines                        | 79            |
| Inspire Series  | 18           | GBG Frozen Drink Machines - Smart & Dream   | 80            |
| Extract Only Series                                   | 19           | GBG Dairy Product Dispenser                 | 81            |
| Standard Sizes  | 20-21        | Whitty Flavoured Syrups                     | 82            |
| Fire Suppression and Ventilation on Demand            | 22           | <b>GENERAL FOOD EQUIPMENT</b>               | <b>83</b>     |
| Baffle Filter   | 23           | <b>HATCO</b>                                | <b>84-112</b> |
| <b>BONN MICROWAVE OVENS</b>                           | <b>24-28</b> | Decorative Heat Lamps ( <b>NEW</b> Model)   | 85-57         |
| Speed Oven  | 24           | Glo Max Strip Heaters                       | 88            |
| Heavy Duty  | 25           | Glo Max Display Lights                      | 89            |
| Medium Duty   | 26-27        | Glo Ray Strip Heaters GRAH & GRAHL          | 90            |
| Light Duty  | 28           | Portable Heated Shelves                     | 91            |
| <b>CARLISLE</b>                                       | <b>29-53</b> | Drop-In Heated Shelves                      | 92            |
| Foodservices Products                                 | 29-53        | Drop-in Hot / Cold and Cold Shelves         | 93            |
| <b>DUKE</b>   | <b>54-57</b> | Drop-in Frost Top                           | 94            |
| Hot Holding Cabinets & Accessories                    | 54-57        | Heated Chutes                               | 95            |
| <b>DYNAMIC</b>  | <b>58-68</b> | 2-Go Heated Shelves                         | 96-97         |
| <b>NEW</b> 3in1 Vegetable slicer and Vegetable slicer | 59           | Portable Food Warmers / Chip Dumps          | 98            |
| <b>NEW</b> Table Top Food Processor & Accessories     | 60-61        | Fry Stations & Multi Product Warmers        | 99            |
| Dynamix Range   | 62           | Conveyor, Pop Up and Programmable Toasters  | 100-103       |
| Junior Series   | 63-64        | <b>NEW</b> Panini Grill                     | 104           |
| Senior Series   | 65           | Plate Warmer                                | 105           |
| Master Series   | 66-68        | Free Standing Drawer Warmers                | 106-107       |
| SMX Series  | 69-71        | Decorative Carving Stations                 | 108           |
| Mixer Support Brackets                                | 71           | Pasta Cooker & Accessories                  | 109-110       |
| Salad Spinners  | 72           | Sanitising Sink Heater                      | 110           |
| Gigamix   | 73           | Built-in Heated Wells (Rectangular & Round) | 111           |
| <b>NEW</b> Turbo Liquidiser                           | 74           | Salamanders                                 | 112           |

Continued >

# CONTENTS

|  |                |
|--|----------------|
| <b>JACKSTACK</b>                             | <b>113</b>     |
| Mobile Plate Racks & Covers                  | 113            |
| <b>JETSTREAM</b>                             | <b>114-125</b> |
| Deck Mount Pre Rinse Models                  | 114-115        |
| Wall Mount Pre Rinse Models                  | 116            |
| Deck Mount Flick Mixers, Thermostatic Mixing | 117            |
| Hands Free & Time Flow Models                | 118            |
| <b>NEW</b> Laser Sensor Models               | 119            |
| Knee Operated Tap & Cleaners Sink Models     | 120            |
| Pot Filler                                   | 120            |
| Deck Mount Swing Faucet / Sink Sets          | 121-122        |
| Wall Mount Swing Faucet / Sink Sets          | 122            |
| <b>NEW</b> Low Line Series                   | 123            |
| Dispensers                                   | 124            |
| Heavy Duty Hose Reels                        | 125            |
| <b>PRINCE CASTLE</b>                         | <b>126-130</b> |
| Bun Toasters                                 | 126            |
| Dedicated Holding Bins                       | 127            |
| Condiment Dispensers                         | 128            |
| Tomato Saber, Core-It, Wedge & Dice Witch    | 129            |
| Grill Brushes, Maintenance Tools, Fry Scoops | 130            |
| <b>PROLUXE</b>                               | <b>131</b>     |
| Compact Split Grill                          | 131            |
| <b>SAN JAMAR</b>                             | <b>132-140</b> |
| Ez-Fit Cup & Lid Dispensers                  | 132            |
| C-Series & Ez-Fit Hot Lid Dispenser          | 133            |
| Wall Mount Foam Cup Dispensers & Wire Works  | 134            |
| Lid Dispensers & Scales                      | 135            |
| Napkin & Straw Dispensers / Organisers       | 136            |
| Pump Systems, Bar Supplies & Safety Wrap     | 137            |
| Ice Handling Solutions & Oven Mitts          | 138            |
| Kleen-Pail & Allergen Safe-T-Zone System     | 139            |
| Docket Holder & Hand Washing Station Combo's | 140            |

|   |                |
|---|----------------|
| <b>SILVERKING</b>                               | <b>141</b>     |
| Drop in Freezer & Dipperwells                   | 141            |
| <b>VINOTEMP</b>                                 | <b>142-146</b> |
| 48-Bottle Single Zone Wine Cooler               | 142            |
| 155-Bottle Dual-Zone Single Door Wine Cooler    | 143            |
| 184-Bottle French Double Door Wine Cooler       | 143            |
| <b>NEW</b> 98 Bottle/200 Can Wine & Bev Centre  | 144            |
| 46 Bottle Dual-Zone Wine Cooler                 | 145            |
| 188-Bottle Backlit                              | 146            |
| <b>VITO</b>                                     | <b>147-150</b> |
| Portable Oil Filter Systems & Oil Tester        | 147            |
| Mobile Oil Filter System                        | 148            |
| <b>NEW</b> Transport Series                     | 149            |
| Accessories & <b>NEW</b> Bluetooth Tester       | 150            |
| <b>YELLOW INDUCTION</b>                         | <b>151-154</b> |
| Portable Counter Top Hobs & New Drop-In         | 151            |
| Drop-In Single Hob Units                        | 152            |
| Built-In Cooktops & <b>NEW</b> Boiling Table    | 153            |
| Multi-Zone Buffet Induction & Remote Generators | 154            |
| <b>YELLOW MIXER</b>                             | <b>155</b>     |
| <b>NEW</b> Planetary Mixer                      | 155            |
| <b>YELLOW TABLE</b>                             | <b>156</b>     |
| Kitchen Accessories                             | 156            |
| <b>ZESTI</b>                                    | <b>157</b>     |
| <b>NEW</b> Icarus Electric Chargrills           | 157            |

Please note that due to our policy of continual improvement, all details and specifications are subject to change without notice.

**PRICES:** Prices shown in this price list are recommended Retail prices only. **RISE & FALL:** Prices are subject to variation at any time without notice and goods will be invoiced at the price current on the date of despatch. **GST:** All prices exclude GST.

# TERMS AND CONDITIONS Effective 1 March 2025

The following Trading Terms supersede all previously terms and condition issued by Us.

## 1. Interpretation

In these Trading Terms and in any quotation, offer, current catalogue, website, price list produced by Us or other agreement with Us, the following definitions apply:

"Account Application Form" means the application form completed and provided by You for the purposes of opening a credit account with Us.

"Goods" means goods supplied by Us to You (and, where the context so permits, shall include any supply of Services) and described in any quotation, offer, current catalogue, website or price list produced by Us.

"Guarantor" means the guarantor(s) described in the Account Application Form, subject to acceptance by Us.

"GST" means the goods and services tax that applies in accordance with A New Tax System (Goods & Services) Act 1999 (Cth).

"Order" means any written, verbal or electronic purchase order made by You for Goods and/or Services.

"Prices" means the prices attributable to the Goods and Services as advised by Us in any quotation, offer, current catalogue, website or price list produced by Us and "Price" shall have a corresponding meaning.

"Services" means all services supplied by Us to You and includes any advice or recommendations (and where the context so permits shall include the supply and installation of any Goods).

"Trading Terms" means these terms and conditions of trade and includes any amendment or variation.

"We" and "Us" means F.S.M. [Food Service Machinery] Pty. Ltd. (ABN 9057185 4991) and includes any Related Bodies Corporate (as defined in the Corporations Act 2001 (Cth)) which supplies Goods and/or Services to You (whether or not the fact is disclosed to You) and "Our" means belonging or pertaining to Us.

"You" means the person, firm or company placing an order with Us for the Goods and "Your" means belonging or pertaining to You.

## 2. Application of Trading Terms

(a) These Trading Terms apply to every sale of Goods and/or supply of Services by Us to You. Each Order made by You and accepted by Us will be an individual contract for those Goods and/or Services in accordance with these Trading Terms.

(b) Subject to any special trading terms agreed to between You and Us and recorded in Your Account Application Form or separately in writing, these Trading Terms (together with any quotation, offer, current catalogue, or price list produced by Us) shall comprise in entirety Our terms and conditions of trade.

(c) In the event of any inconsistency between these Trading Terms and any other document, these Trading Terms shall prevail and any trading terms nominated by You are expressly excluded. Any warranty, representation or guarantee not included or provided for in these Trading Terms is of no effect.

(d) If any part of these Trading Terms, or the application of these Trading Terms to any person or circumstance, is or becomes invalid or enforceable, the remaining provisions of these Trading Terms are not affected and are valid and enforceable to the fullest extent permitted by law.

(e) We may amend these Trading Terms from time to time without notice to You and You will be deemed to have had knowledge of such amendments and have accepted these Trading Terms as amended if You continue to purchase Goods and/or Services from Us after such amendment. Each subsequent supply of Goods and/or Services by Us to You will be in accordance with these Trading Terms as amended.

## 3. Agreement

(a) Any quotation or offer produced by Us is subject to review, amendment or withdrawal at any time prior to acceptance by You or the expiry of the quotation or offer (whichever occurs first).

(b) Subject to (c) of this clause, Our quotation or offer will be deemed to have been accepted by You and a binding agreement entered into with You on the date We receive Your Order.

Any Order which has been accepted by Us may not be cancelled by You without Our written consent (which We may withhold in Our absolute discretion) and then only on the basis that You will indemnify Us in full against all loss (including loss of profit), costs (including the cost of labour and materials used), damages, charges and expenses (including legal costs on a full indemnity basis) incurred by Us as a result of such cancellation. Cancellation of any Orders for Goods which are non-standard manufacture or non-stock items will not be accepted.

(c) We reserve the right to decline, in whole or in part, any Order received from You in Our absolute discretion.

(d) You are solely responsible for determining whether the Goods and Services are suitable for Your intended purposes and meet Your requirements and You acknowledge that no oral or written information, representation or advice given by Us (other than as contained in these Trading Terms) creates a warranty from Us or in any way increases the scope of these Trading Terms.

(e) You agree to notify Us in writing of any change in the ownership or control of Your business structure not less than 7 days prior to such change taking effect and You indemnify Us against any loss or damage We may incur as a result of Your failure to provide such notification.

## 4. Documents

Any clerical or typing errors, misprints or other similar errors in any document produced by Us in respect of Goods and/or Services are subject to correction by Us by either amending or re-issuing the affected document (as the case requires). We shall not be liable for any cost, expense or damage incurred by You as a result of any correction of any document produced by Us.

## 5. Intellectual Property

You acknowledge and agree that:

(a) any intellectual property rights in respect of the Goods and Services (including, but not limited to, rights to design, copyright, patents or trademarks in respect of all drawings, designs, specifications and other information provided by Us in connection with any quotation, offer, current catalogue, website, price list produced by Us) remain Our sole and exclusive property and must remain confidential and You will not attempt to claim any such intellectual property rights in respect of either the Goods and Services or any modification or improvement of the Goods and Services;

(b) You must not attempt to modify or reverse engineer the Goods and Services; and

(c) in all cases where You have provided the design for any Goods and Services, We will not accept any responsibility for any infringement of any design, copyright, patents or trademarks or other intellectual property in connection with the execution of Your Order and You agree to indemnify Us against claims for infringement or unauthorised use of such intellectual property arising out of the manufacture or use of such Goods and Services.

## 6. Prices and Charges

(a) You agree to buy and We agree to sell the Goods and Services for the Prices.

(b) All Prices and all amounts payable to Us are exclusive of GST or any other applicable government tax or duty, unless otherwise indicated. You must pay all such taxes and duties in connection with those amounts.

(c) The Prices include the cost of Our standard packaging for the Goods. The cost of any special packaging materials or techniques requested by You in connection with the Goods must be paid for by You in addition to the Prices.

(d) We reserve the right, from time to time but prior to issuing any invoice to You, to increase the Prices:

(i) to take account of increases in the cost of supplying the Goods and/or Services to You (which may include, but are not limited to, increases in the cost of energy, materials, labour, equipment or delivery) which are due to any factor beyond Our reasonable control or are due to Your failure to provide adequate information or instructions; or

(ii) to correct, without any liability on Our part, any errors or omissions quotation, offer, current catalogue, website or price list produced by Us.

## 7. Payment

(a) We reserve the right to pass on to You any additional costs (including merchant fees) incurred by Us where You pay Us by credit card (if applicable).

(b) If We have not provided credit terms to You, You must pay for the Goods prior to delivery.

(c) If We have provided credit terms to You, You must pay for any Goods and/or Services provided to You within the time period stated in Our invoice or statement for such Goods and/or Services. If We have not stated a time period for payment, You must pay for the Goods and/or Services within 30 days of the end of the month in which we issued Our invoice or statement for the Goods and/or Services.

(d) We may set, alter or withdraw credit limits and terms in Our absolute discretion and without giving prior notice to You or providing reasons.

(e) Payments due to Us must be made without any deduction or set-off. We may apply the amounts paid to Us in payment of any amount owed by You. If You dispute Our invoice or statement, You must still pay the entire amount. We will refund any agreed amount following resolution of the dispute.

(f) If You fail to pay Our invoice or statement (whether in whole or in part) by the due date, without limiting any other provision in these Trading Terms, We may (in Our absolute discretion):

(i) suspend or cancel any further production and/or delivery of any Goods or supply of any Services (whether under an existing or new Order) until full payment of all outstanding amounts owed to Us (including accrued interest if applicable) has been made;

(ii) charge interest on any amount outstanding in respect of Our invoices, at the rate of 1.5% per month, such interest to be calculated daily and compounded monthly, until full payment has been made (such interest rate to be subject to amendment from time to time by Us in Our absolute discretion);

(iii) exercise a general lien on any of Your property within Our possession or control to cover the outstanding amount for the Goods and/or Services;

(iv) withdraw (in full or in part) any discount, concession, allowance or benefit which was previously offered to You; and

(v) recover from You, in addition to the outstanding amount, all costs incurred by Us arising out of or in connection with collecting the outstanding amount (including, but not limited to, expenses and fees associated with or paid to or on account of solicitors, legal advisers, mercantile agents and other agents acting on Our behalf) and the amount payable will be a debt due and payable without demand from the date on which We incur liability for the cost, expense or fee.

Continued >

# TERMS AND CONDITIONS (continued)

## 8. Security Interest and the Personal Property Securities Act 2009 ("PPSA")

If you have a current credit facility in place with Us, You acknowledge and agree that the following terms apply:

(a) We may require You to provide security for any Order placed by You as a condition of accepting Your Order and the terms of the Personal Property Securities Act 2009 (Cth) ("PPSA") apply to all transactions made under these Trading Terms.

(b) You acknowledge and agree that You will:

(i) grant a security interest in all present and after acquired Goods as security for all amounts owing now and in the future by You to Us;

(ii) do all things and sign all documents as are necessary and reasonably required to enable Us to acquire a perfected security interest in all Goods supplied;

(iii) provide such information as is required to enable registration of a 'Purchase Money Security Interest' (as that term is defined in the PPSA) ("PMSI");

(iv) not, without obtaining Our prior written consent, change Your name or initiate any change to any registered documentation, or act in any manner which would impact on Our registered security interest; and

(v) waive or exclude the application of such sections of the PPSA as We may require, subject to those sections being capable of exclusion.

(c) You further acknowledge that a PMSI is granted by You, in priority to all other creditors, in favour of Us and in respect of all Goods We supply to You from time to time, as security for Your payment obligations to Us. You agree to indemnify Us for any liability for all costs (including legal costs on a full indemnity basis) incurred by Us in relation to any security interest granted by You (including, but not limited to, registration, maintenance, enforcement or discharge of any security interest).

(d) We reserve the right at any time to make such amendments, alterations to this 'Security Interest' clause as We may, in Our absolute discretion, determine are necessary to protect Our security interests.

## 9. Title and Risk

(a) Title to and ownership of the Goods shall not pass to You until We have received full payment for the Goods and for any other amounts owing by You in relation to any other matter (including payments in respect of other goods or services provided to You from time to time) and You shall hold the Goods (including where such Goods have been converted or changed by any process) as fiduciary bailee and agent for Us.

(b) Risk in the Goods shall pass to You upon completion of delivery in accordance with these Trading Terms.

(c) You acknowledge that We hold a PMSI (as defined in clause 8) in respect of any Goods supplied to You until We have received full payment in respect of such Goods. You must not pledge, or in any way charge by way of security or indebtedness, any of the Goods until We have received full payment.

(d) Upon taking delivery of the Goods and until We receive full payment for the Goods and for any other amounts owing by You in relation to any other matter, until the Goods are sold by You in the ordinary course of your business, You must:

(i) keep the Goods in Your control and custody and not permit any other person to have possession, custody or control of the Goods;

(ii) keep the Goods separate from any other items or goods in Your possession and mark the Goods to clearly show that the Goods belong to Us;

(iii) not pledge, or in any way charge by way of security or indebtedness, any of the Goods;

(iv) permit Our nominated representative to attend Your premises on prior notice to inspect the Goods; and

(v) deposit all proceeds from the sale of the Goods into a separate and identifiable account, not mix such sale proceeds with any other money and account to Us for such sale proceeds;

and We may trace all such sale proceeds received by You through the relevant account or any other account maintained by You. In addition, You irrevocably appoint Us as Your attorney to recover any such sale proceeds from any purchaser to whom You have on-sold the Goods and to exercise Your rights under any agreement with such purchaser (including rights of repossession and resale of the Goods) provided that We undertake not to exercise such rights as Your attorney unless You have failed to comply with Your payment obligations to Us under these Trading Terms.

(e) Without prejudice to any of Our other rights, if You fail to comply with these Trading Terms, if You cease to be able to pay Your debts as they become due or if You become subject to any form of insolvency administration:

(i) all amounts owing by You to Us shall immediately become due and payable;

(ii) We have the right to immediate possession of the Goods and You irrevocably authorise Us to enter any premises occupied by You at the time upon reasonable notice to You, without liability for trespass or any resulting damage, and take possession of the Goods. You agree to indemnify Us and hold Us harmless from all claims arising out of or in connection with Us taking possession of the Goods in accordance with this clause;

(iii) We may retain all amounts paid to us on account of the Goods and suspend or cancel any further production and delivery of Goods for You;

(iv) We shall be entitled, but not obligated, to resell any Goods repossessed by Us in accordance with this clause; and

(v) We may recover from You all reasonable costs incurred by Us in connection with any Goods repossessed under this clause (including legal costs on a full indemnity basis) and the amount payable will be a debt due and payable without demand from the date on which We incur liability for the cost, expense or fee.

(f) If, at the time We seek to take possession of the Goods in accordance with this clause, the Goods have been incorporated by You in any other item or goods, We will

be treated as owners of such other items or goods together with You, as tenants in common in proportion to our respective contributions.

## 10. Delivery

(a) The delivery dates and completion times contained in any quotation, offer or price list provided to You are estimates only, unless expressly stated to be an essential term and may be varied at any time by Us depending upon the availability of Goods, materials, labour and other contingencies. All backorders will be delivered to You freight free as quickly as Goods become available. All Austream Goods are quoted ex-factory Melbourne or Perth.

(b) In circumstances where the Goods are being shipped to a region where You are arranging collection and unless expressly agreed otherwise in writing by Us, the following terms apply:

(i) the method and date of delivery of all Goods shall be on the terms stated in the quotation, offer or price list provided to You (as applicable) and shall be at Your cost and expense (ex Warehouse from Our Premises) and You agree that in the event that any freight or delivery charges are paid by Us, You must reimburse Us the full amount of such charges on demand;

(ii) delivery of such Goods by Us is complete when the Goods are collected by You or Your nominated agent or carrier; and

(iii) delivery of such Goods is at all time at Your risk.

(c) In circumstances where we have agreed to deliver the Goods to your nominated address for delivery, the following terms shall apply:

(i) If you have a current credit facility in place with Us, and your nominated address for delivery is located in Victoria, New South Wales, ACT, Queensland (excluding far north Queensland), or metropolitan areas of Adelaide or Perth, and Your Order is valued at \$1,200 or more (excl. GST and delivery charges), the Prices quoted for your Order will include delivery costs (FIS);

(ii) all other Orders will be dispatched "freight collect" to your nominated freight account or otherwise by our choice of carrier and a minimum delivery fee of \$30 (excl. GST) will apply where Orders are delivered by our choice of carrier (\$40 (excl. GST) minimum delivery fee to NT and Tasmania), such delivery fees to be subject to amendment from time to time by Us in Our absolute discretion; and

(iii) deliveries will only be made at the ground floor level to a kerbside drop or goods receiving area where it then becomes Your responsibility and expense to supply such labour and equipment as may be necessary to unload Your Order.

## 11. Force Majeure

We will not be liable for any failure to perform, or delay in performance of, any obligation where such failure or delay is due to anything beyond Our reasonable control including, but not limited to, adverse weather or terrain, strikes, lockouts and other industrial action, material shortages, failure of any of Our suppliers to supply, accidents, power or data transmission failure, breakdowns of plant or machinery, war, changes of government, import or export regulations or embargoes.

## 12. Inspection and Return of Goods

(a) You will be deemed to have accepted the Goods, free from any defect or other non-conformity, unless We receive a substantiated claim from You within 7 days from the date of delivery and/or installation of the Goods in accordance with these Trading Terms.

(b) Except where Goods supplied by Us are defective and subject to any warranty:

(i) Goods will only be accepted for return if You have given prior written notice to Us (confirming Your reasons for returning the Goods and stating the applicable invoice number) of Your intention to return the Goods and We have notified You in writing with a completed GRN form that We will accept such return, and that a copy of the GRN Form supplied by us accompanies the goods being returned;

(ii) We may refuse to accept Goods where they are used, no longer in their original packaging or are returned more than 30 days after delivery to You;

(iii) We will refuse to accept the return of any Goods which are non-standard manufacture or non-stock items where such Goods have been correctly delivered by Us;

(iv) delivery of all Goods returned by You must be arranged with Your carrier and is at Your expense and risk; and

(v) in the event that We agree to accept the return of any Goods, You may be required to agree to pay a 15% restocking fee, such fee to be subject to amendment from time to time by Us in Our absolute discretion.

(c) We will only accept the return of Goods from You if the Goods are in the same condition as when the Goods were originally delivered to You, provided that Our acceptance of Goods returned by You is not an acceptance of or granting of credit to You.

Continued >



# TERMS AND CONDITIONS (continued)

## 13. Limitation of Liability and Warranties

(a) The Competition and Consumer Act 2010 (Cth) may imply certain conditions and warranties into these Trading Terms that cannot be excluded or modified. These Trading Terms do not exclude or modify any of those conditions if to do so would contravene that law or make any part of these Trading Terms void.

(b) Where our products are used in a Commercial environment, Subject to the provisions of this clause 13, We will repair or replace any Goods which are manufactured or imported by Us where We, in Our absolute discretion, determine that such Goods, having regard to the materials, workmanship and the reasonable and recommended conditions of use and maintenance, are defective within the period of Warranty (as specified below):

All products within 13 months (Parts & Labour), from the date of delivery to the original Purchaser with the exception of the following:

Asahi Rice Cookers - Back to Base 13 months parts and 13 months labour warranty.

Atlas Shelving - 15 year warranty against rust and corrosion (components only).

Bonn Ovens / Microwaves:

Bonn Models CM-1043T, CM-1052T - Back to Base 24 months parts and 13 months labour warranty.

Bonn Models CM-902T - Back to Base 13 months parts and 13 months labour warranty.

Bonn Models CM-2100G, CM-2101T and CM-1401G-- On Site 24 months parts and 13 months labour.

Duke models - On Site 24 months parts and labour

Dynamic Mixers - All Back to Base 24 months parts and 24 months labour warranty except: GIGAMIX - on-site 24 months parts and 24 months labour warranty.

Edlund - All models Back to Base 13 months except Crown Punch machines.

General Microwaves - Back to Base 13 months parts and 13 months labour warranty.

Hatco - Back to Base Warranty models: GR-FFB, GMFFL, TPT-230-4-10, RCTHW-1E.

Jetstream Tapware - Five Year on-site warranty - excludes faulty installation, sensitivity adjustments on electronic models, failure to instal pressure limiting devices where required.

Jetstream Heavy Duty Hose Reels - 13 month on-site warranty.

Vito - Back to Base Warranty models: all EXCEPT Vito X Vacuum Filtration Systems.

Yellow Induction - Back to Base Warranty models: All Countertop.

Zesti - Icarus models On Site 24 months parts and labour.

Subject to the following conditions:

(i) this warranty will cover parts and labour unless specified otherwise, subject to the following limitations:

(A) damage to cutting blades, toaster elements, light globes, infrared tubes, quartz tubes or any glass items;

(B) where FSM is not responsible for installation - damage caused by improper installation or improper connection to incorrect gas, voltage, incorrect pressure or poor quality water;

(C) damage caused during transit or by accident;

(D) damage caused by negligence, abuse, unauthorised repair or the use of unauthorised spare parts;

(E) damage caused by improper cleaning, maintenance or operation;

(F) damage caused by voltage or gas conversion, pilot light adjustments, thermostat calibrations or any unauthorized alteration or modification;

(G) FSM's liability under this warranty is limited to the repair or replacement of defective Goods and all other costs (including, without limitation, any travel costs, labour costs, overtime rates, installation costs, freight and delivery costs to and from FSM premises to the premises of an authorised repairer, or similar surcharges, fees and costs arising out of a warranty claim are excluded;

(ii) all warranty repair work will be performed between the hours of 8.30 am and 4.30 pm on normal working days;

On site warranty services are limited to sites within 50km from the nearest FSM authorised service agent.

With respect to "Back to Base" warranties, FSM can sell or dispose of any goods:

(i) Not collected by customer or

(ii) Where customer refuses to accept delivery of those goods within 60 days of FSM notifying customer goods are available for collection and/or delivery.

(iii) the warranty period in respect of any spare parts or replacement parts provided under this warranty is limited to 3 months from the delivery of such spare parts or the installation of such replacement parts;

(iv) where the payment terms under these Trading Terms have not been complied with, warranty claims will not be accepted in respect of such Goods;

(v) Risk in any Goods shall remain with You while such Goods are in Our possession for the purposes of assessing a warranty claim and FSM, its servants and agents will not be responsible for any damage caused to the Goods while in Our possession.

(vi) To obtain the benefit of this warranty, You must notify Us in writing immediately upon becoming aware of the alleged defect and in any event within 13 months (or other period as stipulated under item 13) of delivery of the Goods to You (3 months from the delivery of any spare parts or the installation of replacement parts under this warranty).

To the extent that any Goods are not covered under the warranty described in this clause 13(b) but are subject to the original manufacturer's or the original supplier's warranty, FSM will pass on the benefit of such warranty to the extent permitted by law.

(c) Subject to (a) and (b) of this clause 13 and without limiting the terms of any written warranty given separately by Us, all warranties and conditions that may be implied

into these Trading Terms are excluded and Our liability for breach of any implied condition or warranty that cannot be excluded is limited (at Our option) to:

(i) in respect of Goods: the repair or replacement of those Goods or reimbursement of the cost of having those Goods repaired or replaced or refunding to You any payments made in respect of the Goods; and

(ii) in respect of Services: the re-supply of the Services or reimbursement of the cost of supplying the Services again or refunding to You any payments made in respect of the Services.

(d) Despite any other provision of these Trading Terms, to the extent permitted by law, We have no liability to You nor will You be entitled to claim against Us in respect of:

(i) any loss or damage caused by delay in delivery of the Goods or supply of the Services;

(ii) any death or injury arising out of or in connection with the supply of the Goods and/or Services or otherwise at law or in equity;

(iii) any consequential loss or damage (including, but not limited to, loss of profit, loss of revenue, loss of expected savings and opportunity costs) arising out of or in connection with the supply of the Goods and/or Services or otherwise at law or in equity; and

(iv) (if applicable) any loss or damage to Your property or any premises occupied by You arising out of or in connection with Our reasonable installation of the Goods and it is Your responsibility to provide adequate facilities to Us during such installation and to arrange the removal of all waste and hazardous material in connection with the installation process.

(e) You acknowledge that You have not relied on any representation made by Us which is not expressly stated in these Trading Terms.

(f) You acknowledge that You must ensure that the Goods are used and installed (if applicable) in a prudent and professional manner and in accordance with any specifications or instructions which were supplied with the Goods. You indemnify Us against all loss, liability, cost (including legal costs on a full indemnity basis) and expense incurred by Us as a result of any claim made or action brought in connection with the Goods or their use, other than a claim or action brought by You under these Trading Terms or a condition or warranty implied by law which is not excluded by these Trading Terms.

(g) You acknowledge that the exclusions and limitations in this clause are customary for suppliers of goods and services equivalent to the Goods and Services and are fair and reasonable given the nature of the Goods and Services and the applicable Prices.

(h) This clause shall survive termination of these Trading Terms

## 14. Consent to credit check and Privacy Act

(a) By signing the Account Application form, You acknowledge and agree that the Privacy Act 1988 (Cth) allows Us to give a credit reporting agency certain personal information about You at any time after signing such form for the purpose of assessing Your credit worthiness.

(b) You further acknowledge and agree that We may contact any trade reference provided by You or any credit provider and We may acquire information from them or provide information to them in relation to Your credit worthiness.

## 15. Guarantee and Indemnity

(a) The Guarantor hereby guarantees the due and punctual payment by signature of all monies that becomes due and payable by You to Us under these Trading Terms and also the due and punctual performance by You of Your obligations pursuant to these Trading Terms (the "Guarantee").

(b) In consideration for Us entering into these Trading Terms with You, the Guarantor hereby charges in Our favour the whole of the Guarantor's estate and interest, legal and equitable, in the Guarantor's personal and real property to secure the Guarantor's obligations pursuant to these Trading Terms.

(c) Without limiting Our rights under these Trading Terms, the Guarantor acknowledges and agrees that the charge on the Guarantor's property shall provide a caveatable interest in Our favour and the Guarantor consents to Us registering Our interest in the Guarantor's property, including by way of a caveat.

(d) The Guarantee is a continuing guarantee and shall not be discharged in whole or in part by the payment at any time of any part of the money payable by You pursuant to these Trading Terms or by settlement of account, intervening payment, or other matter or thing whatsoever.

(e) The Guarantee shall not be affected or prejudiced by any variation or modification at any time to these Trading Terms.

(f) The Guarantee shall at all times be valid and enforceable against the Guarantor notwithstanding:

(i) that no demand for payment has been made to You; and

(ii) that You were prohibited (whether expressly or by implication) by law, contract or otherwise from entering into these Trading Terms or lacked capacity, power or authority to enter into these Trading Terms.

(g) The Guarantee is irrevocable and shall not be affected by the death, bankruptcy or incapacity of any of the Guarantors.

Continued >

# TERMS AND CONDITIONS (continued)

- (h) If any payment made by You to Us is subsequently avoided or set aside by reason of any statutory provision or otherwise, such payment shall not prejudice or otherwise affect the Guarantee, or Our rights pursuant to this clause 15, to the intent that We shall, with respect to its rights recover pursuant to this clause 15 any monies secured, be restored to the same position in which We would have been had such payment not been made.
- (i) In addition, the Guarantor agrees to indemnify Us in respect of all costs, charges and expenses whatsoever, which We may incur by reason of any default by You under or in relation to these Trading Terms.
- (j) The Guarantor is liable to pay, and indemnify Us for, Our reasonable expenses incurred in enforcing the Guarantee.
- (k) If more than one party signs as Guarantor, in this clause 15 each reference to "Guarantor" is a reference to them jointly and each of the individually.

## 16. General

- (a) We may sub-contract the production, manufacture, supply or delivery of all or some of the Goods and Services.
- (b) Any failure by Us to insist on strict compliance with these Trading Terms or any delay by Us in exercising Our rights under these Trading Terms will not constitute a variation or waiver of any provision of these Trading Terms or of any right available to us.
- (c) If part of all of any provision of these Trading Terms or its application to any person or circumstance is held to be illegal or unenforceable, the provision will be interpreted so as to ensure it is not illegal or unenforceable. If any provision or part of it cannot be so interpreted, the provision or relevant part of it will be severed from these Trading Terms and the remaining provisions of these Trading Terms will continue in force.
- (d) Where You are comprised of 2 or more persons, an agreement or obligation to be performed or observed by You binds those persons jointly and each of them severally.
- (e) Any notice or document required to be served under these Trading Terms will be sufficiently served if delivered or posted by pre-paid post to the address of that party as notified by that party from time to time in writing. If the notice or document is posted, service will be deemed to have been effected 3 days after the date on which the document or notice was posted.

## 17. Governing Law

These Trading Terms are governed by the laws of Victoria. All parties submit to the non-exclusive jurisdiction of the Courts of Victoria, Australia. All parties submit to the non-exclusive jurisdiction of the Courts of Victoria, Australia.

## 18. Consignment Stock

It is agreed the company who is being supplied the consignment stock, shall:

- (a) Shall confirm the Brand, Model Number, Serial number and quantity of each product on consignment within three working days of FSM requesting it.
- (b) Shall keep the item(s) in as new condition and you shall keep the original packaging, instruction manual(s) and warranty card whilst you have the consignment stock in your possession.
- (c) At no time are you to use the consignment stock for demonstration purposes unless you have written confirmation from FSM.
- (d) FSM can request the return of the consignment stock at any time.
- (e) You shall provide insurance cover for all items on consignment under your care.
- (f) You shall place an official purchase order within three working days of any item being sold from your consignment stock.
- (g) Consignment stock cannot be part of a bulk buy discount.
- (h) FSM can invoice you at any time if you fail to follow the conditions.
- (i) All FSM consignment stock remains the property of FSM until it is fully paid for.
- (j) If you want to return any consignment goods to FSM it is your responsibility to ensure the goods are in original packing, insured and any freight costs are your responsibility.
- (k) When purchasing your normal wholesale price applies.



# 3D HEATING TECHNOLOGY

Multiple heating elements delivering uniform temperature for perfect rice every time.



No more dried out or burnt rice with Asahi 3D heating technology. Carefully positioned elements in the base and lid of the CRC-S5000 minimises temperature differences in the cooking chamber.

This uniform temperature creates the ideal environment to cook and hold rice without moisture loss, drying out or burning.



The CRC-S5000 features electronically controlled temperature sensing for perfect rice every time compared to mechanically controlled rice cookers.

## CRC-S5000

- Stainless steel finish
- Capacity 30 cups [5 litres]
- Non-stick easy clean bowl
- Fully automatic one touch operation
- Auto shut-off feature
- Indicator light when cooked
- Multiple heating elements; standard bottom element with additional top elements - provides greater temperature consistency in the bowl.
- Digital temperature sensing for accuracy and reliability
- Cooking and rice warming feature
- Supplied with measuring cup and spoon
- Electrical: 1590 watts, 7A, supplied with 10 amp plug
- Dimensions 450 mm Dia. x 350H;
- Weight: 8.6 kg

LIST PRICE EA. **\$610**

6 BUY PRICE EA. **\$560**



## CRC-S600

- One touch operation
- Capacity up to 33 cups [6 Litres]
- Automatic keep warm function & shut off
- Non stick bowl
- Electrical: 1950 watts, 8A, supplied with 10 amp plug
- Dimensions 310mm Dia. x360H;
- Weight: 6kg

LIST PRICE EA. **\$365**

6 BUY PRICE EA. **\$315**



**4 SHELF WIRE SHELVING BOX KITS**



verde

**WHAT'S IN THE BOX:**

- 4 x POSTS**
- 4 x WIRE SHELVES**
- 4 x PACKS OF SPLIT SLEEVES**

**4-SHELF EPOXY  
WIRE SHELVING  
UNIT**

- Wire design allows for air circulation and minimal dust buildup
- Shelves easily adjust to your exact needs
- 544kg load capacity per unit (136kg per shelf)
- Ideal storage solution for any commercial, food service, medical setting, or home application
- Shelves and posts manufactured with antimicrobial green epoxy finish
- Includes posts, shelves, and all needed hardware
- No tools required for super easy assembly



**ASSEMBLES IN MINUTES**

| CODE      | 455 DEEP - 4 SHELF BOX KITS      | \$  |
|-----------|----------------------------------|-----|
| V18307SET | 760mm SHELVES (18X30") x1830mmH  | 250 |
| V18367SET | 915mm SHELVES (18X36") x1830mmH  | 295 |
| V18427SET | 1065mm SHELVES (18X42") x1830mmH | 310 |
| V18487SET | 1220mm SHELVES (18X48") x1830mmH | 340 |

**NEW FEATURE**

Posts are now half size for easier shipping!





ATLAS shelving features a true powder-epoxy over zinc-chromate electroplating that ensures a strong durable bright silver coloured finish as well as in-built anti-microbial properties to inhibit bacterial growth. This shelving handles high heat and coolroom/freezer/high moisture environments with ease. All ATLAS wire shelving **NOW comes with a 15 YEAR WARRANTY** against rust and corrosion.

All ATLAS wire shelving is manufactured under strict quality control procedures and manufactured with *anti-microbial protection*. The open wire truss reinforced shelves feature front to back welded surface ribs for added strength which increases free air circulation and visibility. Easily adjustable and expandable to change with your needs, shelves adjust on 25 mm (1") increments. Each shelf has a load bearing capacity up to 270 kg (spread evenly across the shelf). Shelving units are available in kit form with four or five shelves, in wire or removable plastic mat to suit any application. Individual shelves, posts and accessories are also available. A large stock inventory allows fast delivery Australia wide.

## 4 SHELF WIRE SHELVING KITS Includes 4 wire shelves, four posts 1830mm high & all hardware

| CODE     | 355 DEEP - 4 SHELVES    | \$  |
|----------|-------------------------|-----|
| 14247EPL | 610mm SHELVES (14X24")  | 346 |
| 14307EPL | 760m SHELVES (14X30")   | 348 |
| 14367EPL | 915m SHELVES (14X36")   | 367 |
| 14427EPL | 1065mm SHELVES (14X42") | 382 |
| 14487EPL | 1220mm SHELVES (14X48") | 387 |
| 14547EPL | 1370mm SHELVES (14X54") | 419 |
| 14607EPL | 1520mm SHELVES (14X60") | 423 |
| 14727EPL | 1830mm SHELVES (14X72") | 475 |

| CODE     | 455 DEEP - 4 SHELVES    | \$  |
|----------|-------------------------|-----|
| 18247EPL | 610mm SHELVES (18X24")  | 384 |
| 18307EPL | 760mm SHELVES (18X30")  | 387 |
| 18367EPL | 915mm SHELVES (18X36")  | 408 |
| 18427EPL | 1065mm SHELVES (18X42") | 425 |
| 18487EPL | 1220mm SHELVES (18X48") | 430 |
| 18547EPL | 1370mm SHELVES (18X54") | 468 |
| 18607EPL | 1520mm SHELVES (18X60") | 470 |
| 18727EPL | 1830mm SHELVES (18X72") | 528 |

| CODE     | 535 DEEP - 4 SHELVES    | \$  |
|----------|-------------------------|-----|
| 21247EPL | 610mm SHELVES (21X24")  | 427 |
| 21307EPL | 760mm SHELVES (21X30")  | 430 |
| 21367EPL | 915mm SHELVES (21X36")  | 453 |
| 21427EPL | 1065mm SHELVES (21X42") | 474 |
| 21487EPL | 1220mm SHELVES (21X48") | 477 |
| 21547EPL | 1370mm SHELVES (21X54") | 520 |
| 21607EPL | 1520mm SHELVES (21X60") | 523 |
| 21727EPL | 1830mm SHELVES (21X72") | 587 |

| CODE     | 610 DEEP - 4 SHELVES    | \$  |
|----------|-------------------------|-----|
| 24247EPL | 610mm SHELVES (24X24")  | 475 |
| 24307EPL | 760mm SHELVES (24X30")  | 477 |
| 24367EPL | 915mm SHELVES (24X36")  | 503 |
| 24427EPL | 1065mm SHELVES (24X42") | 528 |
| 24487EPL | 1220mm SHELVES (24X48") | 530 |
| 24547EPL | 1370mm SHELVES (24X54") | 578 |
| 24607EPL | 1520mm SHELVES (24X60") | 580 |
| 24727EPL | 1830mm SHELVES (24X72") | 654 |

## ACCESSORIES

| CODE  | DESCRIPTION  | \$  |
|-------|--|-----|
| 4CAST | CASTOR KIT<br>includes four castors, two with brakes | 285 |

**NEW FEATURE**  
Posts are now supplied  
in two pieces for easier  
shipping!

## 4 SHELF WIRE ADD-ON SHELVING KITS Includes 4 wire shelves, two 1830mm posts & all hardware

| CODE      | 455 DEEP - 4 SHELVES    | \$  |
|-----------|-------------------------|-----|
| A18247EPL | 610mm SHELVES (18X24")  | 374 |
| A18307EPL | 760mm SHELVES (18X30")  | 376 |
| A18367EPL | 915mm SHELVES (18X36")  | 384 |
| A18427EPL | 1065mm SHELVES (18X42") | 432 |
| A18487EPL | 1220mm SHELVES (18X48") | 436 |
| A18547EPL | 1370mm SHELVES (18X54") | 496 |
| A18607EPL | 1520mm SHELVES (18X60") | 499 |
| A18727EPL | 1830mm SHELVES (18X72") | 558 |

| CODE      | 535 DEEP - 4 SHELVES    | \$  |
|-----------|-------------------------|-----|
| A21247EPL | 610mm SHELVES (21X24")  | 404 |
| A21307EPL | 760mm SHELVES (21X30")  | 410 |
| A21367EPL | 915mm SHELVES (21X36")  | 417 |
| A21427EPL | 1065mm SHELVES (21X42") | 477 |
| A21487EPL | 1220mm SHELVES (21X48") | 477 |
| A21547EPL | 1370mm SHELVES (21X54") | 585 |
| A21607EPL | 1520mm SHELVES (21X60") | 587 |
| A21727EPL | 1830mm SHELVES (21X72") | 671 |

| CODE      | 610 DEEP - 4 SHELVES    | \$  |
|-----------|-------------------------|-----|
| A24247EPL | 610mm SHELVES (24X24")  | 410 |
| A24307EPL | 760mm SHELVES (24X30")  | 410 |
| A24367EPL | 915mm SHELVES (24X36")  | 417 |
| A24427EPL | 1065mm SHELVES (24X42") | 510 |
| A24487EPL | 1220mm SHELVES (24X48") | 512 |
| A24547EPL | 1370mm SHELVES (24X54") | 585 |
| A24607EPL | 1520mm SHELVES (24X60") | 587 |
| A24727EPL | 1830mm SHELVES (24X72") | 671 |

### ACCESSORIES

| CODE  | DESCRIPTION  | \$  |
|-------|--|-----|
| 4CAST | CASTOR KIT<br>includes four castors, two with brakes | 285 |

**TIP**  
to create much more usable shelving in the corner, use the Add-On Kit to eliminate the front corner post.



Add-On units maximise corner space usage and accessibility by eliminating the corner pole.



**15 YEAR WARRANTY**

**5 SHELF WIRE SHELVING KITS** Includes 5 wire shelves, four 1830mm posts & all hardware

| CODE      | 455 DEEP - 5 SHELVES    | \$  |
|-----------|-------------------------|-----|
| 18247EPL5 | 610mm SHELVES (18X24")  | 441 |
| 18307EPL5 | 760mm SHELVES (18X30")  | 444 |
| 18367EPL5 | 915mm SHELVES (18X36")  | 447 |
| 18427EPL5 | 1065mm SHELVES (18X42") | 511 |
| 18487EPL5 | 1220mm SHELVES (18X48") | 513 |
| 18547EPL5 | 1370mm SHELVES (18X54") | 587 |
| 18607EPL5 | 1520mm SHELVES (18X60") | 587 |
| 18727EPL5 | 1830mm SHELVES (18X72") | 664 |

| CODE      | 610 DEEP - 5 SHELVES    | \$  |
|-----------|-------------------------|-----|
| 24247EPL5 | 610mm SHELVES (24X24")  | 501 |
| 24307EPL5 | 760mm SHELVES (24X30")  | 507 |
| 24367EPL5 | 915mm SHELVES (24X36")  | 513 |
| 24427EPL5 | 1065mm SHELVES (24X42") | 606 |
| 24487EPL5 | 1220mm SHELVES (24X48") | 606 |
| 24547EPL5 | 1370mm SHELVES (24X54") | 692 |
| 24607EPL5 | 1520mm SHELVES (24X60") | 700 |
| 24727EPL5 | 1830mm SHELVES (24X72") | 812 |

| CODE      | 535 DEEP - 5 SHELVES    | \$  |
|-----------|-------------------------|-----|
| 21247EPL5 | 610mm SHELVES (21X24")  | 487 |
| 21307EPL5 | 760mm SHELVES (21X30")  | 487 |
| 21367EPL5 | 915mm SHELVES (21X36")  | 494 |
| 21427EPL5 | 1065mm SHELVES (21X42") | 561 |
| 21487EPL5 | 1220mm SHELVES (21X48") | 561 |
| 21547EPL5 | 1370mm SHELVES (21X54") | 640 |
| 21607EPL5 | 1520mm SHELVES (21X60") | 640 |
| 21727EPL5 | 1830mm SHELVES (21X72") | 746 |

**ACCESSORIES**

| CODE  | DESCRIPTION  | \$  |
|-------|--|-----|
| 4CAST | CASTOR KIT<br>includes four castors, two with brakes | 285 |

**TIP**  
to create much more usable shelving in the corner, use the Add-On Kit to eliminate the front corner post.

**5 SHELF WIRE ADD-ON SHELVING KITS** Includes 5 wire shelves, two 1830mm posts & all hardware

| CODE       | 455 DEEP - 5 SHELVES    | \$  |
|------------|-------------------------|-----|
| A18247EPL5 | 610mm SHELVES (18X24")  | 444 |
| A18307EPL5 | 760mm SHELVES (18X30")  | 449 |
| A18367EPL5 | 915mm SHELVES (18X36")  | 451 |
| A18427EPL5 | 1065mm SHELVES (18X42") | 516 |
| A18487EPL5 | 1220mm SHELVES (18X48") | 518 |
| A18547EPL5 | 1370mm SHELVES (18X54") | 593 |
| A18607EPL5 | 1520mm SHELVES (18X60") | 593 |
| A18727EPL5 | 1830mm SHELVES (18X72") | 669 |

| CODE       | 610 DEEP - 5 SHELVES    | \$  |
|------------|-------------------------|-----|
| A24247EPL5 | 610mm SHELVES (24X24")  | 503 |
| A24307EPL5 | 760mm SHELVES (24X30")  | 511 |
| A24367EPL5 | 915mm SHELVES (24X36")  | 518 |
| A24427EPL5 | 1065mm SHELVES (24X42") | 612 |
| A24487EPL5 | 1220mm SHELVES (24X48") | 612 |
| A24547EPL5 | 1370mm SHELVES (24X54") | 700 |
| A24607EPL5 | 1520mm SHELVES (24X60") | 705 |
| A24727EPL5 | 1830mm SHELVES (24X72") | 812 |

| CODE       | 535 DEEP - 5 SHELVES    | \$  |
|------------|-------------------------|-----|
| A21247EPL5 | 610mm SHELVES (21X24")  | 491 |
| A21307EPL5 | 760mm SHELVES (21X30")  | 491 |
| A21367EPL5 | 915mm SHELVES (21X36")  | 498 |
| A21427EPL5 | 1065mm SHELVES (21X42") | 566 |
| A21487EPL5 | 1220mm SHELVES (21X48") | 566 |
| A21547EPL5 | 1370mm SHELVES (21X54") | 645 |
| A21607EPL5 | 1520mm SHELVES (21X60") | 645 |
| A21727EPL5 | 1830mm SHELVES (21X72") | 752 |

**NOTE:**  
All ATLAS shelving kits come complete with shelves, clips, adjustable feet, caps for post tops, and 'S' hooks for add-on units.  
Anti-microbial coating is standard.  
Full installation instructions included and a full **15 YEAR** anti-corrosion warranty.

## SINGLE WIRE SHELVES

| CODE     | 355 DEEP                | \$  |
|----------|-------------------------|-----|
| S1424EPL | 610mm SHELVES (14X24")  | 73  |
| S1430EPL | 760m SHELVES (14X30")   | 75  |
| S1436EPL | 915m SHELVES (14X36")   | 76  |
| S1442EPL | 1065mm SHELVES (14X42") | 79  |
| S1448EPL | 1220mm SHELVES (14X48") | 84  |
| S1454EPL | 1370mm SHELVES (14X54") | 89  |
| S1460EPL | 1520mm SHELVES (14X60") | 93  |
| S1472EPL | 1830mm SHELVES (14X72") | 108 |

| CODE     | 535 DEEP                | \$  |
|----------|-------------------------|-----|
| S2124EPL | 610mm SHELVES (21X24")  | 89  |
| S2130EPL | 760mm SHELVES (21X30")  | 89  |
| S2136EPL | 915mm SHELVES (21X36")  | 91  |
| S2142EPL | 1065mm SHELVES (21X42") | 110 |
| S2148EPL | 1220mm SHELVES (21X48") | 116 |
| S2154EPL | 1370mm SHELVES (21X54") | 122 |
| S2160EPL | 1520mm SHELVES (21X60") | 122 |
| S2172EPL | 1830mm SHELVES (21X72") | 142 |

| CODE     | 455 DEEP                | \$  |
|----------|-------------------------|-----|
| S1824EPL | 610mm SHELVES (18X24")  | 73  |
| S1830EPL | 760mm SHELVES (18X30")  | 76  |
| S1836EPL | 915mm SHELVES (18X36")  | 79  |
| S1842EPL | 1065mm SHELVES (18X42") | 88  |
| S1848EPL | 1220mm SHELVES (18X48") | 102 |
| S1854EPL | 1370mm SHELVES (18X54") | 104 |
| S1860EPL | 1520mm SHELVES (18X60") | 115 |
| S1872EPL | 1830mm SHELVES (18X72") | 121 |

| CODE     | 610 DEEP                | \$  |
|----------|-------------------------|-----|
| S2424EPL | 610mm SHELVES (24X24")  | 90  |
| S2430EPL | 760mm SHELVES (24X30")  | 90  |
| S2436EPL | 915mm SHELVES (24X36")  | 90  |
| S2442EPL | 1065mm SHELVES (24X42") | 103 |
| S2448EPL | 1220mm SHELVES (24X48") | 111 |
| S2454EPL | 1370mm SHELVES (24X54") | 122 |
| S2460EPL | 1520mm SHELVES (24X60") | 124 |
| S2472EPL | 1830mm SHELVES (24X72") | 142 |

## ACCESSORIES

| CODE   | DESCRIPTION  | \$  |
|--------|--|-----|
| 4CAST  | CASTOR KIT includes four castors, two with brakes    | 285 |
| P72EPL | POST 1830mm high, 2 piece post (each)                | 37  |
| AS     | "S" Hooks for add-on shelves (per each)              | 21  |
| AM     | CLIPS (BLACK) Pk of 4 for shelves (1 pack per shelf) | 21  |
| AX     | ADJUSTABLE FEET for posts per each                   | 16  |

## AS EASY AS 1 - 2 - 3 (WIRE SHELVING ADD ON)

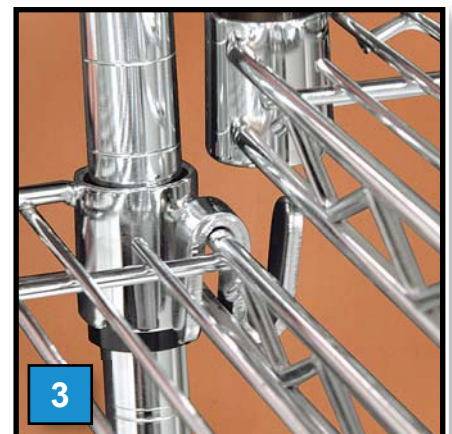



ATLAS Plastic Mat shelving features removable polymer composite mats over a sturdy zinc chromate epoxy coated frame for the best in storage for coolrooms and freezers. Anti-microbial protection is built right into the mat and wire/posts for life-long protection. Easily removed and cleaned, these mats provide a hygienic solution to food storage without having to dismantle shelf units. All ATLAS shelving comes with a 15 Year Warranty against corrosion.

## 4 SHELF PLASTIC MAT SHELVING KITS

Includes 4 plastic mat shelves, four posts 1830mm high & all hardware (adjustable feet, shelf clips, end caps)

| CODE       | 455 DEEP - 4 SHELVES    | \$  |
|------------|-------------------------|-----|
| PM18307EPL | 760mm SHELVES (18X30")  | 571 |
| PM18367EPL | 915mm SHELVES (18X36")  | 575 |
| PM18427EPL | 1065mm SHELVES (18X42") | 663 |
| PM18487EPL | 1220mm SHELVES (18X48") | 705 |
| PM18547EPL | 1370mm SHELVES (18X54") | 776 |
| PM18607EPL | 1520mm SHELVES (18X60") | 785 |
| PM18727EPL | 1830mm SHELVES (18X72") | 922 |

| CODE       | 610 DEEP - 4 SHELVES    | \$   |
|------------|-------------------------|------|
| PM24307EPL | 760mm SHELVES (24X30")  | 693  |
| PM24367EPL | 915mm SHELVES (24X36")  | 700  |
| PM24427EPL | 1065mm SHELVES (24X42") | 827  |
| PM24487EPL | 1220mm SHELVES (24X48") | 834  |
| PM24547EPL | 1370mm SHELVES (24X54") | 965  |
| PM24607EPL | 1520mm SHELVES (24X60") | 969  |
| PM24727EPL | 1830mm SHELVES (24X72") | 1122 |

| CODE       | 535 DEEP - 4 SHELVES    | \$   |
|------------|-------------------------|------|
| PM21307EPL | 760mm SHELVES (21X30")  | 642  |
| PM21367EPL | 915mm SHELVES (21X36")  | 642  |
| PM21427EPL | 1065mm SHELVES (21X42") | 741  |
| PM21487EPL | 1220mm SHELVES (21X48") | 755  |
| PM21547EPL | 1370mm SHELVES (21X54") | 870  |
| PM21607EPL | 1520mm SHELVES (21X60") | 878  |
| PM21727EPL | 1830mm SHELVES (21X72") | 1021 |

**TIP**  
to create much more usable shelving in the corner, use the Add-On Kit to eliminate the front corner post.

## 4 SHELF PLASTIC MAT ADD-ON SHELVING KITS

Includes 4 plastic mat shelves, two posts 1830mm high, S clips & all hardware (adjustable feet, shelf clips, end caps)

| CODE        | 455 DEEP - 4 SHELVES    | \$  |
|-------------|-------------------------|-----|
| APM18307EPL | 760mm SHELVES (18X30")  | 580 |
| APM18367EPL | 915mm SHELVES (18X36")  | 586 |
| APM18427EPL | 1065mm SHELVES (18X42") | 674 |
| APM18487EPL | 1220mm SHELVES (18X48") | 718 |
| APM18547EPL | 1370mm SHELVES (18X54") | 791 |
| APM18607EPL | 1520mm SHELVES (18X60") | 799 |
| APM18727EPL | 1830mm SHELVES (18X72") | 936 |

| CODE        | 610 DEEP - 4 SHELVES    | \$   |
|-------------|-------------------------|------|
| APM24307EPL | 760mm SHELVES (24X30")  | 703  |
| APM24367EPL | 915mm SHELVES (24X36")  | 710  |
| APM24427EPL | 1065mm SHELVES (24X42") | 841  |
| APM24487EPL | 1220mm SHELVES (24X48") | 850  |
| APM24547EPL | 1370mm SHELVES (24X54") | 982  |
| APM24607EPL | 1520mm SHELVES (24X60") | 987  |
| APM24727EPL | 1830mm SHELVES (24X72") | 1141 |

| CODE        | 535 DEEP - 4 SHELVES    | \$   |
|-------------|-------------------------|------|
| APM21307EPL | 760mm SHELVES (21X30")  | 652  |
| APM21367EPL | 915mm SHELVES (21X36")  | 652  |
| APM21427EPL | 1065mm SHELVES (21X42") | 755  |
| APM21487EPL | 1220mm SHELVES (21X48") | 757  |
| APM21547EPL | 1370mm SHELVES (21X54") | 886  |
| APM21607EPL | 1520mm SHELVES (21X60") | 893  |
| APM21727EPL | 1830mm SHELVES (21X72") | 1039 |





## 5 SHELF PLASTIC MAT SHELVING KITS

Includes 5 plastic mat shelves, four posts 1830mm high & all hardware (adjustable feet, shelf clips, end caps)

| CODE        | 455 DEEP - 5 SHELVES    | \$   |
|-------------|-------------------------|------|
| PM18307EPL5 | 760mm SHELVES (18X30")  | 667  |
| PM18367EPL5 | 915mm SHELVES (18X36")  | 700  |
| PM18427EPL5 | 1065mm SHELVES (18X42") | 787  |
| PM18487EPL5 | 1220mm SHELVES (18X48") | 829  |
| PM18547EPL5 | 1370mm SHELVES (18X54") | 920  |
| PM18607EPL5 | 1520mm SHELVES (18X60") | 968  |
| PM18727EPL5 | 1830mm SHELVES (18X72") | 1113 |

| CODE        | 610 DEEP - 5 SHELVES    | \$   |
|-------------|-------------------------|------|
| PM24307EPL5 | 760mm SHELVES (24X30")  | 773  |
| PM24367EPL5 | 915mm SHELVES (24X36")  | 814  |
| PM24427EPL5 | 1065mm SHELVES (24X42") | 821  |
| PM24487EPL5 | 1220mm SHELVES (24X48") | 878  |
| PM24547EPL5 | 1370mm SHELVES (24X54") | 1093 |
| PM24607EPL5 | 1520mm SHELVES (24X60") | 1157 |
| PM24727EPL5 | 1830mm SHELVES (24X72") | 1372 |

| CODE        | 535 DEEP - 5 SHELVES    | \$   |
|-------------|-------------------------|------|
| PM21307EPL5 | 760mm SHELVES (21X30")  | 726  |
| PM21367EPL5 | 915mm SHELVES (21X36")  | 755  |
| PM21427EPL5 | 1065mm SHELVES (21X42") | 854  |
| PM21487EPL5 | 1220mm SHELVES (21X48") | 913  |
| PM21547EPL5 | 1370mm SHELVES (21X54") | 1009 |
| PM21607EPL5 | 1520mm SHELVES (21X60") | 1065 |
| PM21727EPL5 | 1830mm SHELVES (21X72") | 1252 |

**TIP**  
to create a versatile mobile shelving unit, add the castor kit '4CAST' to your shelves - great for periodic cleaning too.

## 5 SHELF PLASTIC MAT ADD-ON SHELVING KITS

Includes 5 plastic mat shelves, two posts 1830mm high, S clips & all hardware (adjustable feet, shelf clips, end caps)

| CODE         | 455 DEEP - 5 SHELVES    | \$   |
|--------------|-------------------------|------|
| APM18307EPL5 | 760mm SHELVES (18X30")  | 700  |
| APM18367EPL5 | 915mm SHELVES (18X36")  | 729  |
| APM18427EPL5 | 1065mm SHELVES (18X42") | 815  |
| APM18487EPL5 | 1220mm SHELVES (18X48") | 859  |
| APM18547EPL5 | 1370mm SHELVES (18X54") | 956  |
| APM18607EPL5 | 1520mm SHELVES (18X60") | 997  |
| APM18727EPL5 | 1830mm SHELVES (18X72") | 1177 |

| CODE         | 610 DEEP - 5 SHELVES    | \$   |
|--------------|-------------------------|------|
| APM24307EPL5 | 760mm SHELVES (24X30")  | 802  |
| APM24367EPL5 | 915mm SHELVES (24X36")  | 842  |
| APM24427EPL5 | 1065mm SHELVES (24X42") | 954  |
| APM24487EPL5 | 1220mm SHELVES (24X48") | 1020 |
| APM24547EPL5 | 1370mm SHELVES (24X54") | 1132 |
| APM24607EPL5 | 1520mm SHELVES (24X60") | 1193 |
| APM24727EPL5 | 1830mm SHELVES (24X72") | 1417 |

| CODE         | 535 DEEP - 5 SHELVES    | \$   |
|--------------|-------------------------|------|
| APM21307EPL5 | 760mm SHELVES (21X30")  | 751  |
| APM21367EPL5 | 915mm SHELVES (21X36")  | 785  |
| APM21427EPL5 | 1065mm SHELVES (21X42") | 885  |
| APM21487EPL5 | 1220mm SHELVES (21X48") | 950  |
| APM21547EPL5 | 1370mm SHELVES (21X54") | 1046 |
| APM21607EPL5 | 1520mm SHELVES (21X60") | 1103 |
| APM21727EPL5 | 1830mm SHELVES (21X72") | 1293 |

## SINGLE PLASTIC MAT SHELVES

| CODE      | 455 DEEP                | \$  |
|-----------|-------------------------|-----|
| PM1830EPL | 760mm SHELVES (18X30")  | 112 |
| PM1836EPL | 915mm SHELVES (18X36")  | 116 |
| PM1842EPL | 1065mm SHELVES (18X42") | 135 |
| PM1848EPL | 1220mm SHELVES (18X48") | 147 |
| PM1854EPL | 1370mm SHELVES (18X54") | 156 |
| PM1860EPL | 1520mm SHELVES (18X60") | 173 |
| PM1872EPL | 1830mm SHELVES (18X72") | 206 |

| CODE      | 610 DEEP                | \$  |
|-----------|-------------------------|-----|
| PM2430EPL | 760mm SHELVES (24X30")  | 135 |
| PM2436EPL | 915mm SHELVES (24X36")  | 140 |
| PM2442EPL | 1065mm SHELVES (24X42") | 165 |
| PM2448EPL | 1220mm SHELVES (24X48") | 174 |
| PM2454EPL | 1370mm SHELVES (24X54") | 202 |
| PM2460EPL | 1520mm SHELVES (24X60") | 217 |
| PM2472EPL | 1830mm SHELVES (24X72") | 259 |

| CODE      | 535 DEEP                | \$  |
|-----------|-------------------------|-----|
| PM2130EPL | 760mm SHELVES (21X30")  | 118 |
| PM2136EPL | 915mm SHELVES (21X36")  | 123 |
| PM2142EPL | 1065mm SHELVES (21X42") | 149 |
| PM2148EPL | 1220mm SHELVES (21X48") | 158 |
| PM2154EPL | 1370mm SHELVES (21X54") | 181 |
| PM2160EPL | 1520mm SHELVES (21X60") | 192 |
| PM2172EPL | 1830mm SHELVES (21X72") | 235 |

## ACCESSORIES

| CODE   | DESCRIPTION  | \$  |
|--------|--|-----|
| 4CAST  | CASTOR KIT includes four castors, two with brakes    | 285 |
| P72EPL | POST 1830mm high, inc. 2 Piece. (per each)           | 37  |
| PMAS   | "S" Hooks for add-on shelves (per each)              | 21  |
| AM     | CLIPS (BLACK) Pk of 4 for shelves (1 pack per shelf) | 21  |
| AX     | ADJUSTABLE FEET for posts per each                   | 16  |



### DID YOU KNOW?

ATLAS shelving has epoxy-coated / electroplated shelving, posts and frames now with anti-microbial protection!

### Why not use our FREE shelf quoting service?

Send us your plans and we'll send you an accurate quote to suit each location, in wire or plastic mat options.

Once ordered, the quote is converted to an invoice/packing ticket, so that each bay is identified on the cartons to make on-site assembly so much easier and faster.

Just another innovative service from FSM Atlas.

With a choice of ventilation systems and technologies to suit any application, Austream canopies can be custom built to your requirements.

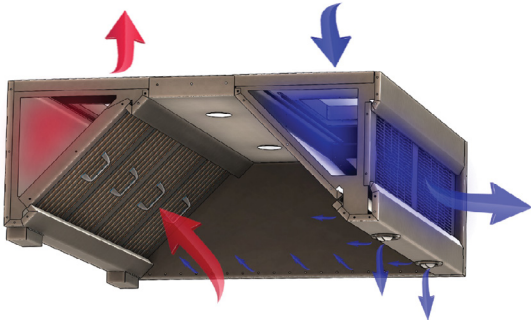

**I SERIES**  
Inspire with supply air

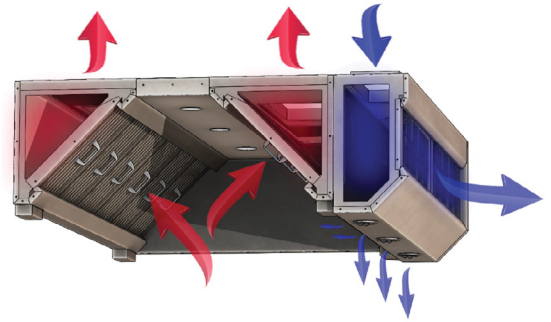

**IEFB SERIES**  
Inspire with dual extract and supply air

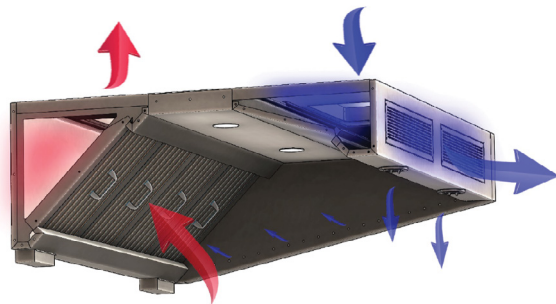

**IR SERIES**  
Inspire with reduced front and supply air (for low height ceilings)

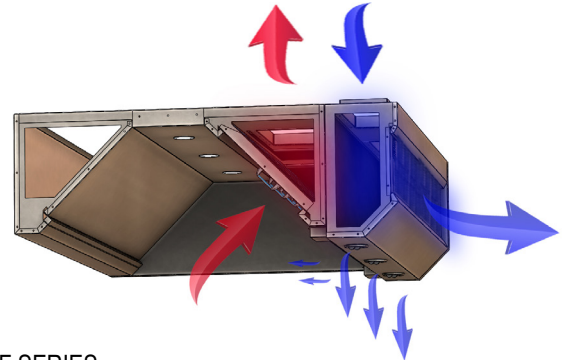

**IEF SERIES**  
Inspire with front extract and supply air

## ADD UV TO YOUR VENTILATION SYSTEM

UV has been used in Kitchen Exhaust hoods for many years and uses processes called photolysis and ozonolysis to break down grease. In photolysis the UV disassociates the bonds within the grease atoms. In ozonolysis, oxygen atoms (O<sub>2</sub>) are disassociated and these recombine into ozone (O<sub>3</sub>). The ozone then reacts with the grease and other organic compounds. The result from these processes is carbon dioxide (CO<sub>2</sub>), water (H<sub>2</sub>O), ozone, products such as peroxyacyl nitrates, and a small amount of white powder (sodium, calcium and organic compounds).

Our High Energy Ozone UV lamps are specifically designed for maximum output in high heat airflows. They are installed in the exhaust plenum inside the hood itself.

**Talk to the team about our NEW FILTER TOOL!**



With a choice of ventilation systems and technologies to suit any application, Austream canopies can be custom built to your requirements.

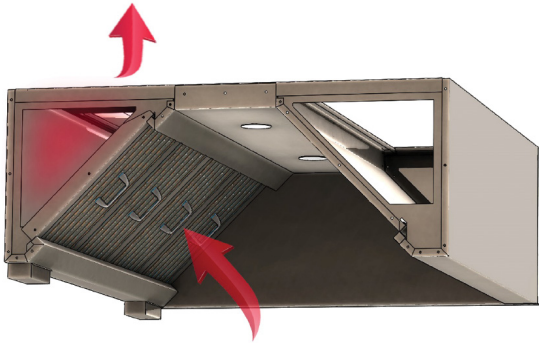

EO SERIES  
Extract only

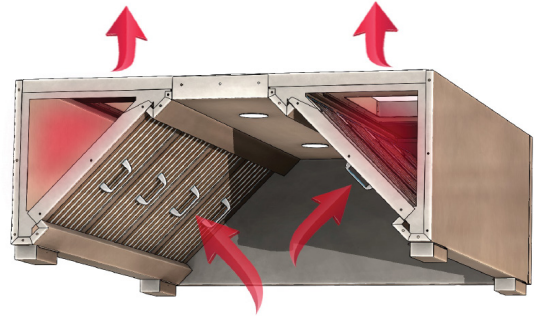

EOFB SERIES  
Extract only front & back

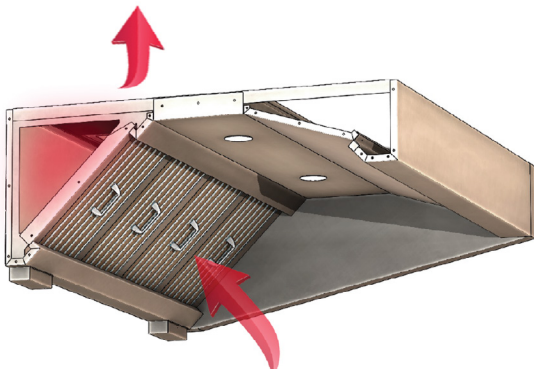

EOR SERIES  
Extract only  
reduced front  
(for low height ceilings)

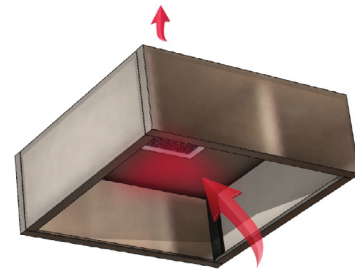

DWE SERIES  
Dishwasher Hood

## Manufacturer Declaration of Conformity to AS1668.2-2024 Austream Kitchen Ventilation Systems

FSM is Australian owned and owns the registered name Austream; a low velocity commercial kitchen ventilation system. Austream is manufactured to the highest European specifications; The German standard VDI2052 and the British specification DW172. Austream is designed to DW172:2018 and meet the criteria of VDI2052:2017. These exhaust hoods are an engineered solution and as such have specific requirements to allow them to perform to their design and comply directly to BCA 2022 Volume 1, Clause F6.D12.

Austream canopies utilise UL-1046 listed filters and comply with AS1668.1-2015 Clause 6.2.9.

Austream low velocity hoods meet and exceed the requirements of AS1668.2-2024. Section 3, clause 3.6 of the standard states: "Ventilated ceilings and proprietary kitchen exhaust hoods not covered under Clauses 3.4 and 3.5 shall be designed to one of the following: (a) VDI 2052 (b) EN 16282-1 (c) ASTM-F1704 (d) DW-172 (e) UL 710 (f) ANSI/ASHRAE Standard 154. VDI2052:2017 and DW172:2018 are widely adopted and used throughout Australia and both exceed the requirements of the AS1668.2-2014 standard and this can be proven through existing installations in Australia.

| Standard Lengths (mm) | Numbers of Sections | Number of Filters | Number of LED Lights | Weight (kg) |
|-----------------------|---------------------|-------------------|----------------------|-------------|
| 1200                  | 1                   | 3                 | 2                    | 85          |
| 1350                  | 1                   | 3                 | 2                    | 95          |
| 1550                  | 1                   | 4                 | 2                    | 110         |
| 1700                  | 1                   | 4                 | 2                    | 120         |
| 1900                  | 1                   | 5                 | 3                    | 125         |
| 2050                  | 1                   | 5                 | 3                    | 130         |
| 2250                  | 1                   | 6                 | 3                    | 135         |
| 2400                  | 1                   | 6                 | 3                    | 150         |
| 2650                  | 2                   | 7                 | 4                    | 175         |
| 2800                  | 2                   | 7                 | 4                    | 185         |
| 3000                  | 2                   | 8                 | 4                    | 190         |
| 3150                  | 2                   | 8                 | 4                    | 200         |
| 3350                  | 2                   | 9                 | 5                    | 210         |
| 3500                  | 2                   | 9                 | 5                    | 220         |
| 3700                  | 2                   | 10                | 6                    | 225         |
| 3850                  | 2                   | 10                | 6                    | 230         |
| 4050                  | 2                   | 11                | 6                    | 235         |
| 4200                  | 2                   | 11                | 6                    | 240         |
| 4400                  | 2                   | 12                | 6                    | 260         |
| 4550                  | 2                   | 12                | 6                    | 265         |
| 4800                  | 3                   | 13                | 7                    | 290         |
| 4950                  | 3                   | 13                | 7                    | 310         |
| 5150                  | 3                   | 14                | 8                    | 315         |
| 5300                  | 3                   | 14                | 8                    | 330         |
| 5500                  | 3                   | 15                | 9                    | 335         |
| 5650                  | 3                   | 15                | 9                    | 345         |
| 5850                  | 3                   | 16                | 9                    | 350         |
| 6000                  | 3                   | 16                | 9                    | 360         |
| 6200                  | 3                   | 17                | 9                    | 365         |
| 6350                  | 3                   | 17                | 9                    | 370         |
| 6550                  | 3                   | 18                | 9                    | 375         |
| 6700                  | 3                   | 18                | 9                    | 385         |

Standard depths 1300 and 1650. Standard sizes are available in a faster time frame and are more cost effective.  
Custom sizes available on request - sample sizes only above.

| Standard Lengths | Numbers of Sections | Number of Filters | Number of LED Lights | Weight (kg) |
|------------------|---------------------|-------------------|----------------------|-------------|
| 6950             | 4                   | 19                | 11                   | 455         |
| 7100             | 4                   | 19                | 11                   | 460         |
| 7300             | 4                   | 20                | 12                   | 470         |
| 7450             | 4                   | 20                | 12                   | 475         |
| 7650             | 4                   | 21                | 12                   | 480         |
| 7800             | 4                   | 21                | 12                   | 485         |
| 8000             | 4                   | 22                | 12                   | 490         |
| 8150             | 4                   | 22                | 12                   | 495         |
| 8350             | 4                   | 23                | 12                   | 500         |
| 8500             | 4                   | 23                | 12                   | 505         |
| 8700             | 4                   | 24                | 12                   | 510         |
| 8850             | 4                   | 24                | 12                   | 515         |
| 9100             | 5                   | 25                | 15                   | 585         |
| 9250             | 5                   | 25                | 15                   | 590         |
| 9450             | 5                   | 26                | 15                   | 595         |
| 9600             | 5                   | 26                | 15                   | 600         |
| 9800             | 5                   | 27                | 15                   | 605         |
| 9950             | 5                   | 27                | 15                   | 610         |
| 10150            | 5                   | 28                | 15                   | 615         |
| 10300            | 5                   | 28                | 15                   | 620         |
| 10500            | 5                   | 29                | 15                   | 625         |
| 10650            | 5                   | 29                | 15                   | 630         |
| 10850            | 5                   | 30                | 15                   | 635         |
| 11000            | 5                   | 30                | 15                   | 640         |

Standard depths 1300 and 1650. Standard sizes are available in a faster time frame and are more cost effective.  
Custom sizes available on request - sample sizes only above.

## MADE TO ORDER, ANY SIZE

FSM has been trading in Australia since 1976 and has established a national reputation for providing high quality food service equipment to all sectors of the industry. We continue to innovate and lead the way in trends, with the Austream kitchen ventilation system being a new solution available to provide our customers with long term solutions that improve their productivity and the bottom line.

## FIRE SUPPRESSION

The fire suppression system features ANSULEX liquid suppressant, a potassium acetate solution that effectively combats cooking and grease fires by suffocation and cooling. The stainless steel agent tank, equipped with a mild steel dip tube and burst disc assembly, ensures durability and reliable performance. The system is powered by the ANSUL R-102 AUTOMAN mechanical release module, a spring-loaded device capable of actuating one to four cylinder assemblies using a nitrogen cylinder, with activation triggered either automatically via a detection network or manually through a remote pull station. Chrome-plated brass discharge nozzles, designed for specific applications and UL300-listed, provide precise and effective suppressant delivery, with each nozzle featuring engraved flow numbers and discharge patterns for easy identification.

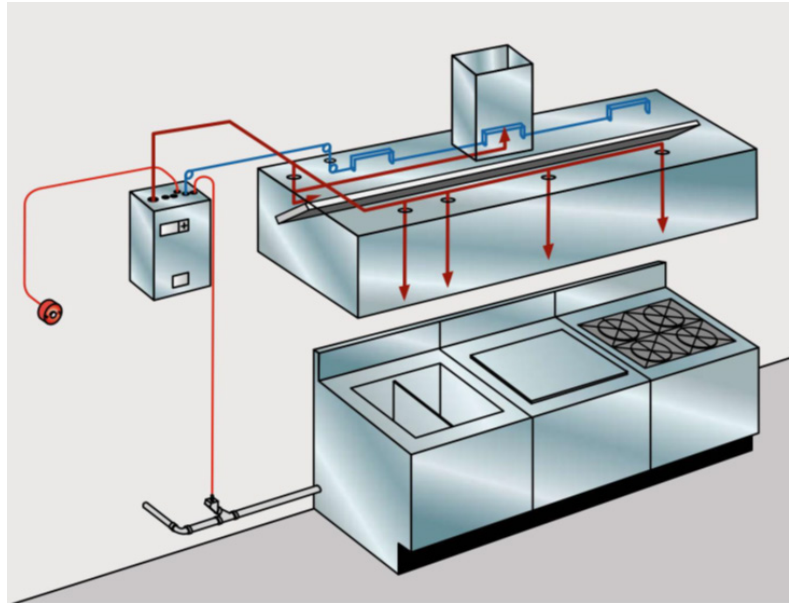

**Knocks Kitchen  
Fires Out Fast**



**Flexible  
Protection**



**Meets Multiple  
Global 3rd Party  
Approvals**

## VENTILATION ON DEMAND

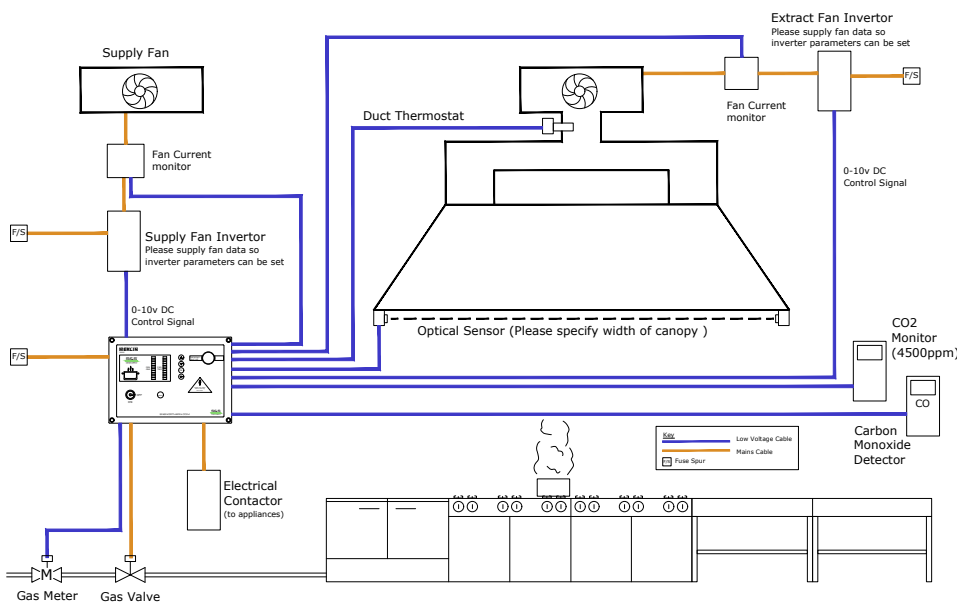

The Merlin 3000S is an advanced energy-saving system tailored for commercial kitchens, serving as an interlock between ventilation and gas supply while optimizing ventilation speeds via dual 0-10VDC outputs. It dynamically adjusts fan speeds based on real-time gas consumption, CO2 levels, and inputs from optical and heat sensors, ensuring a comfortable and efficient cooking environment. By increasing ventilation during high activity and reducing it during low demand, the system significantly cuts energy usage, minimizes heat loss, and reduces noise. Fully compliant with industry standards (BS6173:2009, ISEM/UP19, and more), it also integrates gas pressure proving and ventilation control into a compact panel, maximizing kitchen wall space.



## SUPERSTREAM 3050SP

High Performance 75% Grease Efficiency Baffle Filter



### SUPERSTREAM 3050SP HIGH PERFORMANCE BAFFLE FILTER FEATURES:

- High Performance Baffle Filter 75% Grease efficiency at 8 micron
- 100% Flame barrier protection to DIN 18869-5 **with built in spark arrestor**
- Cutsafe safety edges
- Fully welded construction – all stainless steel construction
- Meets insurance requirements
- Meets **AS 1668.1-2015** requirements
- **Centre** handle and drain holes as standard
- Robust baffle filter construction – built to last
- Tested & certified to European standard DIN 18869-5
- Tested to American standard UL1046
- Tested & certified to ASTM 2519

### APPLICATIONS

- Commercial kitchens
- Spark arrestors



### ✓ USER FRIENDLY

- + Touch mode interface with smart menu system, controls are intuitive and simple to use.
- + **Easy to clean:** Infra-red elements tilt-up for cleaning.
- + Removable metal rack and bottom jetplate.
- + Allows the use of the metal trays, pans, screens, simplifies cooking.
- + Built-in self-diagnostics.

### ✓ HIGH SPEED WITH LESS NOISE

- + Quick heat up.
- + Variable-speed, vertically recirculated air convection and impingement, can heat, brown, and crisp powerfully and intelligently with low noise.
- + supplied with 15 amp cord + plug.
- + Stirrer to help ensure even distribution of air and microwave.
- + 383Wmm x 693Dmm x 610Hmm

### ✓ DURABLE AND LONG LASTING

- + Exterior 430 stainless steel.
- + Interior 304 stainless steel.
- + Insulated cook chamber.

### ✓ CONVENIENT AND ADAPTABLE TO YOUR NEEDS

- + Three "Set TEMP" modes to meet different temperature requirement.
- + Temperature setting: 0-280°C.
- + Total 432 recipes with multi-stage programming (Up to 6 stages for each recipe).
- + Edit recipe and image on both oven and PC.
- + USB port to load recipes and photos.
- + Mounts almost flush to wall.
- + Bake, roast, toast, brown, and crisp foods. You pick!

### ✓ CONSISTENT RESULTS ALWAYS

- + The Bonn oven is a combination of forced convection, high speed tuned impinged air, top launched microwave that guarantees even and consistent results.
- + Built-in catalytic converter breaks down grease-laden vapors, allowing for ventless operation.



**ACCESSORIES INCLUDED**  
Teflon basket, rack, baking stone, non-stick baking pad, paddle

SCIQ2  
LIST PRICE EA. **\$13,990**





## HIGH PERFORMANCE SERIES MICROWAVES

### Bonn CM-2101T

- 2100 Watts of Cooking Power
- 15 Amp plug single phase
- 18L Capacity
- Digital Touch-Pad Controls with LED Lighted Display
- 100 Program Menu Settings
- 4 Stages of Cooking
- Commercial Grade Performance
- Made for Continuous Operation
- Stainless Steel Body & Cavity
- Dual Magnetron
- Heavy Duty Metal Handle & Durable Interlock System
- Stackable (2 high)
- 420W x 563D x 340H mm | Weight: 31kgs

LIST PRICE EA.

**\$2895**



**NOW ONSITE 36 MONTHS PARTS AND  
13 MONTH LABOUR WARRANTY**

### CPS3A MicroSave Dishwasher Safe Cavity Liner - purchased seperately:

LIST PRICE EA.

**\$350**

(Save \$20.00 when purchased with oven)

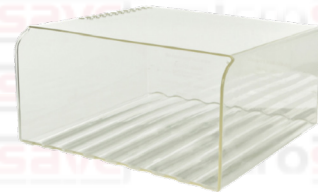

### Bonn CM-1401G

- 1400W Microwave Output, 5 Power Levels
- Spacious 34L Capacity
- Digital Touch-Pad Controls
- 100 Program Menu Settings
- 3 Stages of Cooking
- 60 Minute Maximum Cook Time
- Commercial Grade Performance
- Made for Continuous Operation
- Stainless Steel Body & Cavity
- Heavy Duty Metal Handle
- Durable Interlock System
- 10 Amp plug single phase
- Door construction: Toughened Glass, Commercial quality Hinges and handle
- External Dimensions 553W x 488D x 343H mm | Weight: 25Kgs

**ONLY  
REQUIRES  
10A POWER**



LIST PRICE EA.

**\$2490**

### CPS6A MicroSave Dishwasher Safe Cavity Liner - purchased seperately:

LIST PRICE EA.

**\$350**

(Save \$20.00 when purchased with oven)

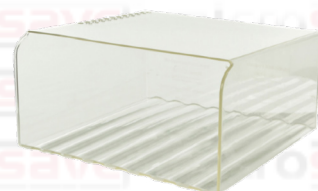



# Bonn

The Bonn Performance Series Microwaves offer users preset programming, ceramic base, full stainless steel construction, generous 21 litre capacity and a choice of output power.

Incorporating the latest generation high efficiency Magnetron, these models incorporate many of the design features from the Bonn High Performance Range of ovens, including Direct Ducted Magnetron cooling, motorised stirrer fan for even heating along with all the safety features such as toughened inner door glass, heavy duty door safety latches and double-strengthened door hinges - all part of Bonn's stringent total safety philosophy.

Get commercial quality and speed with ease of operation and superior Bonn quality.

Supplied with 24 Month Parts / 13 Month Labour Back to Base Warranty\*

## Performance Range Features

### Grab'n'Go Door Handle

Heavy Duty trigger-less metal door handle for years of reliable use.



### Direct Ducted Magnetron Cooling Design

Industry leading magnetron life span. Unique ducted design by Bonn. Cold air is plumbed directly into the magnetron, with hot exhaust air plumbed to exit the oven achieving maximum cooling efficiency.

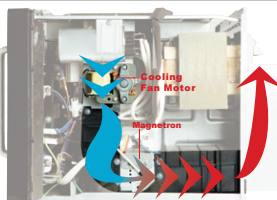

### Programmable Touch Pad

20 programmable presets for easy, rapid heating of meals.



### High Efficiency Magnetron

Latest generation magnetron design enabling power output up to 1200 watts.

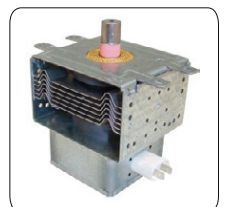

### Heavy Duty Door Safety Latch

Heavy Duty nylon door latches, guarantees maximum safety to user.



### Safety

Toughened glass (not film) inner door screen protects door grill, preventing possible microwave leakage and maximum safety to user.



### Motorised Stirrer Fan

Concealed Stirrer Fan for even heating of food.



### Ceramic Base

Easy clean up of spills and larger useable space when compared to rotating glass turntable.





## PERFORMANCE SERIES MICROWAVES

### Bonn CM-1043T

- **1200W** Microwave Output, 5 Power Levels
- 10 Amp plug single phase (Max. Draw 8.5A)
- **27 Litre Internal capacity**
- 20 Preset Memories, Digital Display
- Full Stainless Steel Interior/Exterior
- Door construction: Toughened Glass, Commercial quality Hinges and handle
- External Dimensions 511W x 382D x 330Hmm
- Internal Dimensions 330W x 330D x 212Hmm
- Carton Dimensions 590W x 465D x 395Hmm
- Net Weight: 17.5Kgs Ship Weight 21kg



LIST PRICE EA.

**\$1420**

### Bonn CM-1052T

- **1000W** Microwave Output, 4 Power Levels
- 10 Amp plug single phase (Max. Draw 7.6A)
- **25 Litre Internal capacity**
- 10 Preset Memories, Digital Display
- Full Stainless Steel Interior/Exterior
- Door construction: Toughened Glass, Commercial quality Hinges and handle
- External Dimensions 510W x 382D x 330Hmm
- Internal Dimensions 330W x 330D x 212Hmm
- Weight: 17.5Kgs



LIST PRICE EA.

**\$1040**

## LIGHT DUTY SERIES MICROWAVES

The Bonn Light Duty Microwave Series offers the smaller users preset programming (10 presets), ceramic base, stainless steel exterior, large 25 litre capacity and 900 Watt output.

Incorporating several of the design features from the Bonn Performance Range of ovens, including motorised stirrer fan for even heating and ceramic base.

This entry level commercial oven offers ease of operation and Bonn quality.

Supplied with our exclusive 13 month Back to Base labour and parts warranty\*.

### Bonn CM-902T

- 900W Microwave Output, 4 Power Levels
- 10 Amp plug single phase (Max. Draw 6.5A)
- 25 Litre Internal capacity
- 10 Preset Memories, Digital Display
- Programmable 1 to 3 stage cooking
- Rugged hinges and door handle
- Stainless Steel Exterior
- Stainless Steel Interior with Ceramic base
- External Dimensions 510W x 380Dmm x 335H
- Internal Dimensions 330W x 330Dmm x 212H
- Weight: 15 Kgs

LIST PRICE EA.

**\$595**



# CARLISLE

FOODSERVICE PRODUCTS



Foodservice Trays



Catering Equipment



Food Bars & Convenience



Bar Supplies



Kitchen Accesories



Storage & Handling



Floor & Restroom Care



Warewashing



Waste Management



Cleaning Tools



Brushes & Accessories



Dishware & Disposables





**Peace of Mind at a Glance**

CoolCheck has all of the features of standard Coldmaster pans with the added benefit of color changing technology. Hold contents at or below the food safe temperature of 40°F for up to 6-8 hours. When the unit is no longer at a safe temperature, the color change indicates it's time to exchange the CoolCheck with a fresh one.



**Benefits**

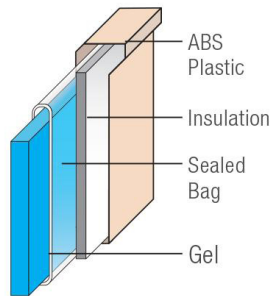

**Color Changing Technology**

Color fades from blue to white when temperatures are no longer safe

**Maintain Food Safe Temperatures**

6-8 hours of hold time for maximum food protection

**Convenient and Clean**

StorPlus EZ Access  
Hinged Lids available

**Fast and Efficient**

Store temperature-sensitive food in-line for ultra-fast service

| CODE        | DESCRIPTION - White / Blue   | Pack Size | Dimensions         | \$ EA  |
|-------------|--|-----------|--------------------|--------|
| CM1100C1402 | Coldmaster® CoolCheck® Full-Size Food Pan 1/1  | 1         | 323W x 525L x 163H | 295.00 |
| CM1101C1402 | Coldmaster® CoolCheck® Half-Size Food Pan 1/2  | 1         | 263W x 323L x 153H | 245.00 |
| CM1102C1402 | Coldmaster® CoolCheck® Third-Size Food Pan 1/3   | 1         | 175W x 323L x 153H | 140.00 |
| CM1104C1402 | Coldmaster® CoolCheck® Sixth-Size Food Pan 1/6 Size  | 1         | 158W x 173L x 150H | 125.00 |
| CODE        | DESCRIPTION - White / Blue   | Pack Size | Dimensions         | \$ EA  |
| CM104902    | Coldmaster® Full size 153mm Deep Coldpan with Organizer White   9 ninth-size food pans (pans not included) | 1         | 407W x 610L x 190H | 740.00 |



## Ultimate Durability & Timeless Classic

Carlisle Polycarbonate pitchers are break resistant and come in a variety of sizes and shapes. An industry favorite for decades, this timeless design looks great and takes the drama out of serving and pouring.



## Benefits



### Polycarbonate Construction

Resists staining, breaking and chipping



### Tapered Lip

Makes pouring with ice easy



### Ergonomic Handle & Thumb Grip

Aids in control of pitcher while pouring



### Optimised Wall Thickness

More strength and durability without the weight

| Code   | Description   | Pack Size | Dimensions           | \$ PACK |
|--------|---|-----------|----------------------|---------|
| 554007 | Versapour® Pitcher - Polycarbonate 1.77L   Sure Grip handle   Base Diameter 92mm   Top Diameter 127mm | 6         | 127W x 127L x 210Hmm | 109.80  |







## Benefits



**Made of chip-, shatter-, and break-resistant SAN**

**Dishwasher safe**

**Attractive exteriors**

**Made to stack**

| Code   | Description   | Pack Size | Dimensions         | \$ PACK |
|--------|---|-----------|--------------------|---------|
| 580807 | Louis™ SAN Tumbler 240ml   Stackable design   Dishwasher safe   Bottom Diameter 58mm   Top Diameter 77mm          | 24        | 76W x 76L x 86Hmm  | 150.00  |
| 581007 | Louis™ SAN Tumbler 300ml   Stackable design   Dishwasher safe   Bottom Diameter 55mm   Diameter 73mm              | 24        | 74W x 74L x 116Hmm | 124.80  |
| 400807 | Crystalon® Stack-All® SAN Tumbler   Stackable design   Dishwasher safe   Bottom Diameter 53mm   Top Diameter 71mm | 48        | 71W x 71L x 103Hmm | 136.80  |



# Square Bowls



## Benefits



**Made of chip-,  
shatter-, and  
break-resistant  
SAN**



**Dishwasher safe**



**Easy content  
identification**



**Space saving  
square shape fits  
corner of trays**

| Code       | Description   | Pack Size | Dimensions          | \$ PACK |
|------------|---|-----------|---------------------|---------|
| DXSB607    | Dinex Square Bowl 175ml - Clear   Look of china with the durability and cost savings of plastic   Dishwasher safe | 96        | 104W x 104L x 36Hmm | 324.00  |
| DXSB1203   | Dinex Square Bowl 350ml - Black   Look of china with the durability and cost savings of plastic   Dishwasher safe | 48        | 104W x 104L x 59Hmm | 347.00  |
| DX11840174 | Dome Lid for Square Bowl - Clear (Fits DXSB607 & DXSB1203) Stack count 100   NSF Certified Facility               | 1000      | 104W x 104L x 7Hmm  | 322.00  |
| DXSQD1007  | Dinex Square Bowl 290ml - Reusable clear dish and disposable dome lid for easy content identification             | 48        | 102W x 102L x 45Hmm | 226.00  |
| Code       | Description   | Pack Size | Dimensions          | \$ PACK |
| DXSWC507   | Dinex Tulip Cup- Swirl 150ml - Clear   Diameter 95mm  | 96        | 89W x 89L x 83Hmm   | 310.00  |





## Benefits



**Highly heat- and break-resistant (190007 Image)**



**Dishwasher safe (198907 Image)**



**Polycarbonate (PC) is resistant to staining, breaking and chipping**



**Clear covers for easy viewing of food**

| Code   | Description                            | Pack Size | Dimensions          | \$ PACK |
|--------|--|-----------|---------------------|---------|
| 190007 | Clear Plate Cover   Polycarbonate (PC) | 12        | 238W x 238L x 65Hmm | 163.20  |
| 198907 | Clear Plate Cover   Polycarbonate (PC) | 12        | 270W x 270L x 77Hmm | 198.00  |

## Foodservice Products

| Code    | Description   | Pack Size | Dimensions        | \$ PACK |
|---------|---|-----------|-------------------|---------|
| WPM8538 | Chrome Tapered, Medium Flow - Chrome                    | 12        | 26W x 26L x 77Hmm | 85.80   |
| OP30500 | Pour Free Economical Free Flow Pourer - Red; BPA free * | 12        | 26W x 26L x 76Hmm | 10.80   |



\* Available whilst stock lasts





## Benefits



Offers easy measuring of wet ingredients (4314107 Image)



Oval shape facilitates pouring from non-spouted side



Nest for storage (4314207 Image)

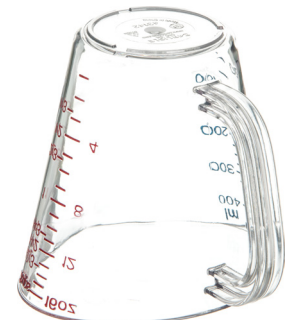

Made of durable, dishwasher safe polycarbonate

| Code    | Description                                    | Pack Size | Dimensions           | \$ PACK |
|---------|--|-----------|----------------------|---------|
| 4314107 | Commercial Measuring Cup 250ml   NSF approved  | 12        | 111W x 102L x 84Hmm  | 140.00  |
| 4314207 | Commercial Measuring Cup 500ml   NSF approved  | 6         | 130W x 121L x 107Hmm | 120.00  |
| 4314307 | Commercial Measuring Cup 1000ml   NSF approved | 6         | 161W x 147L x 135Hmm | 140.00  |

## Foodservice Products



| Code   | Description                       | Pack Size | Dimensions         | \$ PACK |
|--------|-----------------------------------|-----------|--------------------|---------|
| 430607 | Polycarbonate Scoop 180ml   Clear | 12        | 82W x 276L x 56Hmm | 94.80   |



## GripLite® An Economical Alternative

Quality construction ensures limited slipping and sliding of glasses and dinnerware.



### Benefits

#### Sturdy

Polypropylene copolymer construction

#### Fewer Spills

Molded-in rubber liner prevents slipping and sliding

#### Stain & Odor Resistant

Maintains appearance longer

#### Alternative to Cork

A more sanitary alternative to cork trays

| Code      | Description                        | Pack Size | \$ PACK |
|-----------|------------------------------------|-----------|---------|
| 1400GL004 | GripLite® Round Tray 360mm - Black | 12        | 220.80  |
| 1600GL004 | GripLite® Round Tray 420mm - Black | 12        | 374.40  |

## Griptite™ Best Grip

Built from the ground up; the Griptite 2 tray is unmatched. The long-life, non-skid surface grips drinkware and plates better – reducing spills, breakage, and cost. The coated tray edge is a bumper against heavy daily use. We take our trays through rigorous testing to ensure they excel in both function and durability.



### Benefits

#### Less Slip & Tip

Holds a full glass at a steeper angle than ever before

#### Durable Materials

Impact and drop tested for superior performance

#### Beautiful Surface

Looks great longer by resisting stains

#### Long Lasting

Field-tested to withstand years of high-demand serving

| CODE       | DESCRIPTION                        | Pack Size | \$ PACK |
|------------|------------------------------------|-----------|---------|
| 1400GR2004 | Griptite™ Round Tray 360mm - Black | 12        | 504.00  |
| 1600GR2004 | Griptite™ Round Tray 420mm - Black | 12        | 687.60  |





## Durability and Cleanability at an Affordable Price

Glasteel Fiberglass Trays are engineered to be the most durable fiberglass tray available.



## Benefits

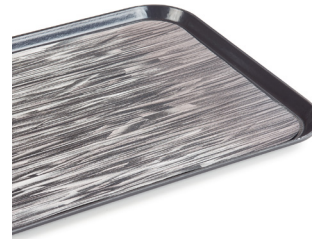

### Heavy-Duty

Metal reinforcing rods provide extra strength and eliminate warping (DX1089M23 image)

### Chemical Resistant

Thick, fiberglass core mats provide strength and chemical resistance

### Reduced Dry Time

Air flow corner reinforcements and stacking lugs (DXSMC1520NSQ44 image)

### Added Stability

Reinforced core mats add strength and stability (DXSMC1520NSQ44 image)

| Code            | Description  | Pack Size | Min Order Qty | \$ PACK |
|-----------------|--|-----------|---------------|---------|
| DX1089M23       | Glasteel™ Flat Tray 381 x 508mm - Gray   Top-of-the-line Glasteel construction   Dishwasher safe                                 | 12        | 12            | 549.96  |
| DXSMC1520N-SQ44 | Glasteel™ Quarry Non-Skid Tray 381 x 508mm - Graphite Grey   Stain, scratch & odor resistant   Dishwasher safe and easy to clean | 12        | 12            | 940.00  |
| 2015FG002       | Glasteel™ Fiberglass Tray 381 x 514mm - Smoke Grey   Top-of-the-line Glasteel construction   Dishwasher safe                     | 12        | 360           | 620.00  |

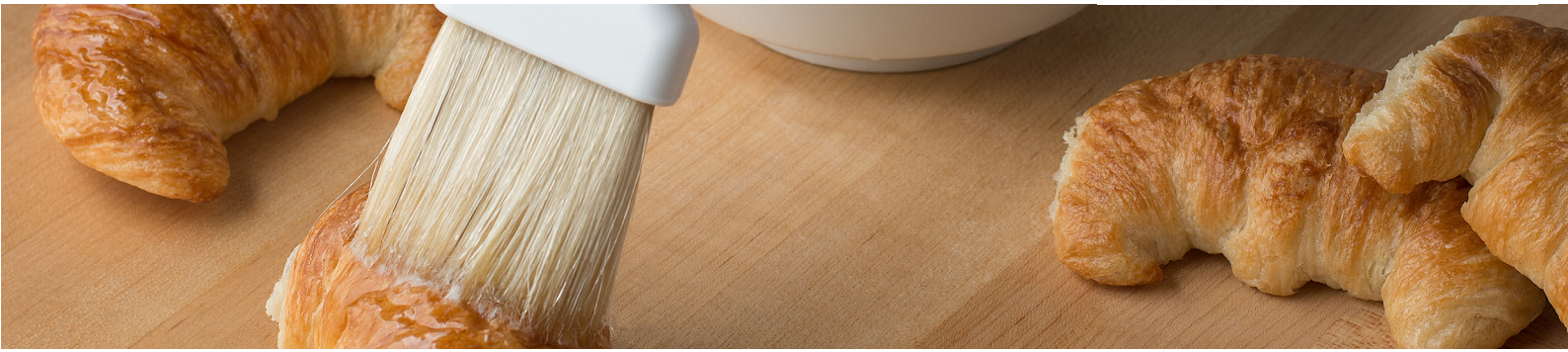

## Sparta® Galaxy™ Pastry Brushes

One piece plastic handles are easy to clean

Bristles are epoxy-set to ferrules to prevent bacteria harboring air pockets

Available with soft flagged nylon bristles or double-boiled, bleached, sterilized premium boar bristles

Select brushes also available with Blue nylon bristles for added contrast in working with white frosting or other white foods your foodservice operation.



| CODE    | DESCRIPTION  | Pack Size | \$ PACK |
|---------|--|-----------|---------|
| 4039002 | Galaxy™ Flat Brush w/Nylon Bristles 38mm - White, Soft White Nylon bristles have high fluid retaining capacity | 12        | 222.00  |

## Sparta® Chef Series Brushes

Sparta® Chef Series Brushes are ideal for using in a multitude of kitchen and food prep applications. High-quality, lacquered hardwood handles detail each brush and are ergonomically shaped for easy one-handed use. The professional brushes offer bleached nylon or sterilized boar bristles which are epoxy-set to prevent the harboring of bacteria.



| CODE    | DESCRIPTION  | Pack Size | \$ PACK |
|---------|--|-----------|---------|
| 4037400 | Sparta® Flat Boar Bristle Brush 50mm   Boar Bristles – Sterilized, natural bristles provide excellent fluid retention and are epoxy-set to prevent harboring of bacteria | 12        | 258.00  |
| 4037800 | Sparta® Meteor ® Boar Bristle Basting Brush 50mm   Molded hook protects brush from heat damage and allows brush to rest on container rim                                 | 12        | 264.00  |





## Sparta® Grill Bricks & Polishing Pads

Apply with cooking oil to protect the grill cure and remove excess cooked-on foods

40710 Grill Brick is a fast, efficient, and sanitary way to clean hot or cold grills

Plastic wrapping on Grill Brick dissolves to eliminate mess

40713 Grill Screen and 40711 Grill Polishing Pad attach to the 40712 Grill Pad Holder for a complete grill maintenance system



| CODE    | DESCRIPTION                                      | Pack Size | \$ PACK |
|---------|--|-----------|---------|
| 4071000 | Sparta® Grill Brick 8", 4", 3-1/2" - Black       | 12        | 114.00  |
| 4071100 | Sparta® Grill Polishing Pads 5", 4", 1/4" - Red* | 6         | 120.00  |

\* Available whilst stock lasts

## Sparta® Wire Brushes & Scrapers

Wire brushes and Stainless Steel metal Scrapers make quick and easy removal of heavy Carbon deposits, rust, and burned-on food build up

Available with wood handles for cleaning hot grills and ovens



| CODE    | DESCRIPTION   | Pack Size                 | \$ EA |
|---------|---|---------------------------|-------|
| 4029000 | Sparta® Broiler Master; Stainless steel wire bristles and scrapers; Excellent for removing heavy carbon deposits, rust and burned on food build up. One side of the brush has semi stiff and the other with coarse bristles; Head 216W x 127H x 775Lmm; Bristle length 25mm | 6<br>(available as each)  | 94.00 |
| 4029300 | Pizza Oven Brush with Scraper; Crimped Brass wire bristles and a full length Aluminum Scraper; 89mm wide; Bristle length 32mm   | 12<br>(available as each) | 58.00 |
| 4067100 | Sparta® Scratch Brush and Scraper; Blue; Carbon Steel Bristles; Bristle length 32mm; Brush size 140mm; Total length 291mm   | 12<br>(available as each) | 19.00 |



## Food Holding Day After Day

Perfect for all cold applications including buffets, cold wells, service line applications, and fridge/freezer storage



## Benefits



### Smooth Interior

Makes clean-up easy



### Reinforced Corners

Prevent chips and cracks and stand up to drops and use day after day



### Universally Stackable

Stackable with all food pan products on the market



### Spoonable Bottoms

Remove contents easier and reduce food waste

| CODE     | DESCRIPTION - Polycarbonate Clear       | Pack Size | Dims (mm)           | \$ EA |
|----------|---|-----------|---------------------|-------|
| 10200B07 | StorPlus™ Food Pan Full-Size 65mm deep  | 1         | 324W X 527L   6.6L  | 22.20 |
| 10201B07 | StorPlus™ Food Pan Full-Size 100mm deep | 1         | 324W X 527L   13.3L | 28.45 |
| 10202B07 | StorPlus™ Food Pan Full-Size 150mm deep | 1         | 324W X 527L   24.1L | 38.00 |
| CODE     | DESCRIPTION - Polycarbonate Black       | Pack Size | Dims (mm)           | \$ EA |
| 10202B03 | StorPlus™ Food Pan Half-Size 150mm deep | 1         | 324W X 527L   24.1L | 37.00 |



# StorPlus™ Polycarbonate Food Pans



| CODE     | DESCRIPTION - Polycarbonate Clear       | Pack Size | Dims (mm)           | \$ EA |
|----------|---|-----------|---------------------|-------|
| 10220B07 | StorPlus™ Food Pan Half-Size 65mm deep  | 1         | 324W X 264L   3.12L | 12.50 |
| 10221B07 | StorPlus™ Food Pan Half-Size 100mm deep | 1         | 324W X 264L   5.7L  | 15.00 |
| 10222B07 | StorPlus™ Food Pan Half-Size 150mm deep | 1         | 324W X 264L   8L    | 19.00 |
| CODE     | DESCRIPTION - Polycarbonate Black       | Pack Size | Dims (mm)           | \$ EA |
| 10220B03 | StorPlus™ Food Pan Half-Size 65mm deep* | 1         | 324W X 264L   3.12L | 12.50 |
| 10221B03 | StorPlus™ Food Pan Half-Size 100mm deep | 1         | 324W X 264L   5.7L  | 15.00 |
| 10222B03 | StorPlus™ Food Pan Half-Size 150mm deep | 1         | 324W X 264L   8L    | 19.00 |

\* Available whilst stock lasts

| CODE    | DESCRIPTION - Polycarbonate Clear      | Pack Size | Dims (mm)          | \$ EA |
|---------|--|-----------|--------------------|-------|
| 3066007 | StorPlus™ Food Pan 1/3 Size 65mm deep  | 1         | 324W X 175L   2.6L | 9.00  |
| 3066107 | StorPlus™ Food Pan 1/3 Size 100mm deep | 1         | 324W X 175L   3.6L | 12.00 |
| 3066207 | StorPlus™ Food Pan 1/3 Size 150mm deep | 1         | 324W X 175L   5.3L | 14.50 |
| CODE    | DESCRIPTION - Polycarbonate Black      | Pack Size | Dims (mm)          | \$ EA |
| 3066003 | StorPlus™ Food Pan 1/3 Size 65mm deep* | 1         | 324W X 175L   2.6L | 9.00  |
| 3066103 | StorPlus™ Food Pan 1/3 Size 100mm deep | 1         | 324W X 175L   3.6L | 12.00 |
| 3066203 | StorPlus™ Food Pan 1/3 Size 150mm deep | 1         | 324W X 175L   5.3L | 14.50 |

\* Available whilst stock lasts

| CODE    | DESCRIPTION - Polycarbonate Clear       | Pack Size | Dims (mm)          | \$ EA |
|---------|---|-----------|--------------------|-------|
| 3068007 | StorPlus™ Food Pan 1/4 Size 65mm deep   | 1         | 162W X 175L   1.8L | 9.00  |
| 3068107 | StorPlus™ Food Pan 1/4 Size 100mm deep  | 1         | 162W X 175L   2.7L | 10.50 |
| 3068207 | StorPlus™ Food Pan 1/4 Size 150mm deep  | 1         | 162W X 175L   4.3L | 12.40 |
| CODE    | DESCRIPTION - Polycarbonate Black       | Pack Size | Dims (mm)          | \$ EA |
| 3068003 | StorPlus™ Food Pan 1/4 Size 65mm deep*  | 1         | 162W X 175L   1.8L | 9.00  |
| 3068103 | StorPlus™ Food Pan 1/4 Size 100mm deep* | 1         | 162W X 175L   2.7L | 10.50 |
| 3068203 | StorPlus™ Food Pan 1/4 Size 150mm deep* | 1         | 162W X 175L   4.3L | 12.00 |

\* Available whilst stock lasts



| CODE    | DESCRIPTION - Polycarbonate Clear      | Pack Size | Dims (mm)           | \$ EA |
|---------|--|-----------|---------------------|-------|
| 3068307 | StorPlus™ Food Pan 1/6 Size 65mm deep  | 1         | 137W X 151L   0.95L | 7.00  |
| 3068407 | StorPlus™ Food Pan 1/6 Size 100mm deep | 1         | 137W X 151L   1.9L  | 8.00  |
| CODE    | DESCRIPTION - Polycarbonate Black      | Pack Size | Dims (mm)           | \$    |
| 3068303 | StorPlus™ Food Pan 1/6 Size 65mm deep* | 1         | 137W X 151L   0.95L | 7.00  |
| 3068403 | StorPlus™ Food Pan 1/6 Size 100mm deep | 1         | 137W X 151L   1.9L  | 8.00  |
| 3068503 | StorPlus™ Food Pan 1/6 Size 150mm deep | 1         | 137W X 151L   2.4L  | 10.00 |

\* Available whilst stock lasts

| CODE    | DESCRIPTION - Polycarbonate Clear          | Pack Size | Dims (mm)           | \$ EA |
|---------|--|-----------|---------------------|-------|
| 3068607 | StorPlus™ Food Pan 1/9 Size 65mm deep      | 1         | 108W X 175L   0.68L | 7.00  |
| 3068707 | StorPlus™ Food Pan 1/9 Size 100mm deep     | 1         | 108W X 175L   1.09L | 10.50 |
| 3068807 | StorPlus™ Food Pan 1/9 Size 150mm deep     | 1         | 108W X 175L   1.32L | 10.00 |
| CODE    | DESCRIPTION - Polycarbonate Black          | Pack Size | Dims (mm)           | \$ EA |
| 3068703 | StorPlus™ Food Pan 1/9 Size 100mm deep     | 1         | 108W X 175L   1.09L | 8.00  |
| 3068803 | StorPlus™ Food Pan 1/9 Size 150mm deep* ST | 1         | 108W X 175L   1.32L | 13.00 |

\* Available whilst stock lasts

## Full Size



| Size Inches | Size mm |
|-------------|---------|
| 2 1/2"      | 65      |
| 4"          | 100     |
| 6"          | 150     |
| 8"          | 200"    |





| CODE    | DESCRIPTION - Polycarbonate Clear        | Pack Size | Dims (mm)   | \$ EA |
|---------|--|-----------|-------------|-------|
| 1021507 | StorPlus™ Drain Shelf 1/1 Size 15mm deep | 1         | 251W x 451L | 17.00 |
| 1023507 | StorPlus™ Drain Shelf 1/2 Size 15mm deep | 1         | 194W x 254L | 8.00  |
| 3067007 | StorPlus™ Drain Shelf 1/3 Size 15mm deep | 1         | 121W x 264L | 7.00  |
| 3069507 | StorPlus™ Drain Shelf 1/4 Size 14mm deep | 1         | 107W x 206L | 6.00  |
| 3068907 | StorPlus™ Drain Shelf 1/6 Size 13mm deep | 1         | 108W x 121L | 3.00  |
| 1033507 | StorPlus™ Drain Shelf 1/9 Size 16mm deep | 1         | 61W x 127L  | 3.00  |

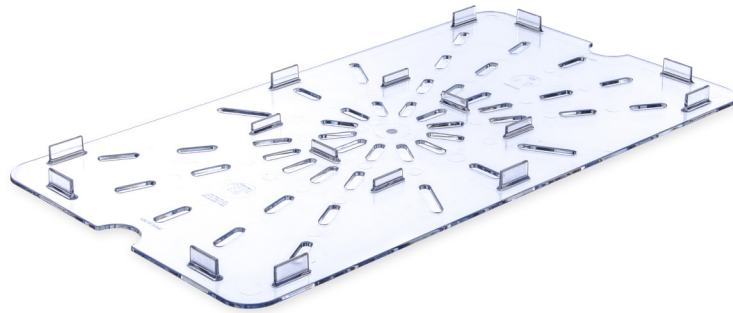

| CODE     | DESCRIPTION - Polycarbonate Clear | Pack Size | Dims (mm)   | \$ PACK |
|----------|-----------------------------------|-----------|-------------|---------|
| 10210U07 | StorPlus™ Handled Lid 1/1 Size    | 6         | 251W x 451L | 108.00  |



| CODE     | DESCRIPTION - Polycarbonate Clear                                  | Pack Size | Dims (mm)           | \$ PACK |
|----------|--|-----------|---------------------|---------|
| 10279Z07 | StorPlus™ EZ Access Hinged Notched Universal Food Pan Lid 1/3 Size | 6         | 178W x 324L x 28Hmm | 102.00  |
| 10319Z07 | StorPlus™ EZ Access Hinged Notched Universal Food Pan Lid 1/6 Size | 6         | 160W x 175L x 28Hmm | 57.00   |
| 10339Z07 | StorPlus™ EZ Access Hinged Notched Universal Food Pan Lid 1/9 Size | 6         | 110W x 175L x 28Hmm | 60.00   |



# StorPlus™ High Heat Food Pans



- High heat pans excel in high temperature applications (-40°F to 375°F)
- Reinforced top and bottom corners on both pan and lid helps prevent chipping and cracking
- Spoonable bottoms makes removal of contents easier and helps prevent food waste
- Molded-in capacity indicators are listed in both quarts and liters
- Textured non-slip finish on corners, sides, bottom and lid reduce scratches
- Smooth interior finish makes clean-up easy
- Food Pan sizes meet specifications for use in food bars and steam tables
- Pans meet EN 631-1 Euro Norm standards for inter-stacking with existing pans
- NSF Listed; dishwasher safe



| CODE      | DESCRIPTION - High Heat Amber                   | Pack Size | \$  |
|-----------|---|-----------|-----|
| 30860HH13 | StorPlus™ Food Pan Double Handle 1/3 Size 65mm  | 1         | 75  |
| 30861HH13 | StorPlus™ Food Pan Double Handle 1/3 Size 102mm | 1         | 88  |
| 30860H13  | StorPlus™ Food Pan Single Handle 1/3 Size 65mm  | 1         | 73  |
| 30861H13  | StorPlus™ Food Pan Single Handle 1/3 Size 102mm | 1         | 86  |
| 30860HH13 | StorPlus™ Food Pan Double Handle 1/3 Size 65mm  | 12        | 860 |
| 30861HH13 | StorPlus™ Food Pan Double Handle 1/3 Size 102mm | 12        | 975 |
| 30860H13  | StorPlus™ Food Pan Single Handle 1/3 Size 65mm  | 12        | 840 |
| 30861H13  | StorPlus™ Food Pan Single Handle 1/3 Size 102mm | 12        | 955 |

| CODE     | DESCRIPTION - High Heat Amber          | Pack Size | \$  |
|----------|--|-----------|-----|
| 10400B13 | StorPlus™ Food Pan 1/1 Size 65mm deep  | 1         | 115 |
| 10401B13 | StorPlus™ Food Pan 1/1 Size 100mm deep | 1         | 142 |
| 10420B13 | StorPlus™ Food Pan 1/2 Size 65mm deep  | 1         | 58  |
| 10421B13 | StorPlus™ Food Pan 1/2 Size 100mm deep | 1         | 76  |





| CODE     | DESCRIPTION  | Pack Size | Image | \$ EA  |
|----------|--|-----------|-------|--------|
| BIN2702  | Ingredient Bin; Capacity 102 Litre; Colour White; Heavy duty non-marking castors. Lids slide for easy opening; 724L x 322W x 708Hmm  | 1         |       | 600.00 |
| BIN3602  | Ingredient Bin; Capacity 136 Litre; Colour White; Heavy duty non-marking castors. Lids slide for easy opening; 750 L x 390 W x 718Hmm  | 1         |       | 650.00 |
| 34201523 | TrimLine™ Rectangle Waste Container; Capacity 57L; Colour Grey; Fits narrow spaces; Self-venting for easier bag removal; Handle helper on base for easy lifting; 508L x 267W x 629Hmm  | 1         |       | 103.00 |
| 34202323 | TrimLine™ Rectangle Waste Container Capacity 87L; Colour Grey; Fits narrow spaces; Self-venting for easier bag removal; Handle helper on base for easy lifting; 510L x 280W x 762Hmm   | 1         |       | 135.00 |
| 34202303 | TrimLine™ Rectangle Waste Container; Capacity 87L; Colour Black; Fits narrow spaces; Self-venting for easier bag removal; Handle helper on base for easy lifting; 510L x 280W x 762Hmm | 1         |       | 135.00 |
| 36921003 | "TrimLine™ Dolly Colour Black; To suit 34202303 / 34201523; 330W x 560Lmm with 76mm castors"   | 1         |       | 198.00 |
| 34202403 | "TrimLine™ Rectangle Swing Top Waste Container Lid; Colour Black; 513L x 294W x 114Hmm"  | 1         |       | 98.00  |





| CODE     | DESCRIPTION   | Pack Size | Image | \$ EA  |
|----------|---|-----------|-------|--------|
| 84101023 | Bronco™ Grey Round Waste Bin; Capacity 121L; Heavy duty construction with double reinforced stress ribs; Drag skids for durability; Bottom dia 457mm x 705Hmm; Top dia 579mm; Top dia with handles 648mm<br>OLD CODE 34103223 | 1         |       | 90.00  |
| 34101023 | Bronco™ Grey Round Bin; Capacity 37L; Heavy duty construction with double reinforced stress ribs; Drag skids for durability; Bottom dia 317mm x 432Hmm; Top dia 410mm; Top dia with handles 446mm                             | 6         |       | 40.00  |
| 34102003 | Bronco™ Black Round Bin; Capacity 75L; Heavy duty construction with double reinforced stress ribs; Drag skids for durability; Bottom dia 413mm x 585Hmm; Top dia 508mm; Top dia with handles 585mm                            | 6         |       | 70.00  |
| 34102023 | Bronco™ Grey Round Bin; Capacity 75L; Heavy duty construction with double reinforced stress ribs; Drag skids for durability; Bottom dia 413mm x 585Hmm; Top dia 508mm; Top dia with handles 585mm                             | 6         |       | 70.00  |
| 34102123 | Bronco™ Round Waste Bin Lid to Suit 75 Litre Bronco™ Round Waste Bin; Colour Grey; Dimensions: 508mm dia x 32Hmm  | 1         |       | 20.00  |
| 3691103  | Bronco™ Round Waste Container Dolly; Suits Bronco™ Round Waste Bins; Simple twist-to- lock feature attaches dolly to container; Five 76mm castors; 454mm dia x 127Hmm   | 2         |       | 130.00 |



| CODE      | DESCRIPTION  | Pack Size | Image   | \$ EA   |
|-----------|--|-----------|---|---------|
| UC452523  | Large Bin Top Utility Cart; Colour Grey; Durable, chemical resistant polypropylene construction; Dent, rust & chip resistant. Weight capacity per shelf 113kg; 76mm high "lip" prevents objects from falling during transit. 1143L x 685W x 838Hmm | 1         |    | 750.00  |
| UC194023  | Flat Shelf Utility Cart; Colour Grey; Durable, chemical resistant polypropylene construction; Dent, rust & chip resistant. Weight capacity per shelf 113kg; 1026L x 483W x 830Hmm  | 1         |    | 550.00  |
| JC1945L23 | Long Platform Janitorial Cart; Colour Grey; 125L x 54W x 99Hmm; Versatile organisation; Rugged polyethylene; 68mm non-marking castors in front with 204mm non-marking wheels in the rear; Convenient waste collection.                             | 1         |   | 560.00  |
| SBC203103 | Large Fold 'N Go® Cart; Colour Black; Unfolded dimensions 520W x 1016L x 1099Hmm; Collapses to 267W x 1016Lmm; Easy to store in limited space; Non-marking castors; 20mm solid aluminium legs; Weight capacity per shelf 53kg;                     | 1         |  | 1720.00 |
| SBC152103 | Small Fold 'N Go® Cart; Colour Black; Unfolded dimensions 406W x 749L x 908Hmm; Collapses to 229W x 749Lmm; Easy to store in limited space; Non-marking castors; 20mm solid aluminium legs; Weight capacity per shelf 53kg;                        | 1         |  | 1250.00 |



| CODE     | DESCRIPTION  | Pack Size | Image | \$ EA   |
|----------|--|-----------|-------|---------|
| XT500003 | Cateraide™ Insulated Beverage Server; Capacity 19L; Colour Black; Stain & scratch resistant polyethylene exterior; Temperature retention for 6-8 Hr; Max temp 82.2°C; Spout clearance 127mm; 430L x 267W x 654Hmm  | 1         |       | 550.00  |
| IT40003  | Cateraide™ IT End Loading Insulated Food Pan Carrier<br>Colour Black; 676L x 460W x 740Hmm; Temperature retention for 6+ Hr; Capacity:<br>6 x Full size 65mm pans (12 x half size) OR<br>4 x Full size 100mm pans (8 x half size) OR<br>2 x Full size 150mm pans (4 x half size) OR<br>1 x Full size 200mm pans                    | 1         |       | 1220.00 |
| IT41003  | Cateraide™ Dolly to Suit IT40003 Pan Carrier; Colour Black; 76mm non-marking wheels; 676L x 473W x 245Hmm  | 1         |       | 460.00  |
| PC600N03 | Cateraide™ 2-Door Insulated Food Pan Carrier; Colour Black; 616L x 432W x 1270Hmm; Temperature retention for 6+ Hr; 127mm non-marking castors; Capacity:<br>10 x Full size 65mm pans (20 x half size) OR<br>6 x Full size 100mm pans (12 x half size) OR<br>4 x Full size 150mm pans (8 x half size) OR<br>1 x Full size 200mm pan | 1         |       | 2480.00 |
| PC300N03 | Cateraide™ Insulated Front Loading Food Pan Carrier<br>Colour Black; 616L x 432W x 641Hmm<br>Temperature retention for 6+ Hr; Nyllex Latches;<br>Capacity:<br>5 x Full size 65mm pans (10 x half size) OR<br>3 x Full size 100mm pans (8 x half size) OR<br>2 x Full size 150mm pans (4 x half size) OR<br>1 x Full size 200mm pan | 1         |       | 1080.00 |



| CODE        | DESCRIPTION   | Pack Size | Image   | \$ EA   |
|-------------|---|-----------|---|---------|
| PC66014     | CaterCooler™ Exclusive CaterCooler; Colour: Blue; Designed to slide into a Cateraide™ Insulated Carriers (PC300N03, PC600N03) Once charged overnight, keeps food cold for up to 8 hrs   | 1         |     | 215.00  |
| IC225003    | Cateraide™ Ice Caddy on Castors; 56kg ice capacity; 2 fixed and 2 swivel castors 1 with brake; Dimensions including handle 711L x 565W x 730Hmm   | 1         |   | 2150.00 |
| IC222003    | Cateraide™ Ice Caddy on Castors; 90kg ice capacity; 2 fixed and 2 swivel castors 1 with brake; Dimensions including handle 781L x 559W x 927Hmm   | 1         |  | 2400.00 |
| LD250N03    | Cateraide™ LD Insulated Beverage Server; Colour Black; Capacity 9.5L; Keeps beverages hot or cold for up to 4-6 hours; Nylex II Latches; Dimensions 419L x 229 x 457Hmm   | 1         |  | 520.00  |
| XDL3000 H03 | Cateraide™ Dolly with Handle; Colour Black; 100mm heavy duty non-marking castors; Holds up to 2 XT3000R Pan Carriers when stacked; Holds all Cateraide™ Top Loader Pan Carriers except PC180N and PC188N. Dimensions 730L x 570W x 994Hmm | 1         |  | 570.00  |





## Spread, Scoop & Serve Perfect Portions

With Color-Coded Measure Misers®, you can spread, scoop and serve perfect portions of food with ease and precision. Choose a solid cup bottom for thicker foods or a perforated bottom for dishing out juicy vegetables and other side dishes. Varying handle lengths lend themselves use in a variety of bin bins and pots—perfect for a busy catering environment or restaurant. Each miser color is dedicated to a certain size, so make food service quicker by dishing out precise portions with ease!



## Benefits



### Precise Portioning

Measured cup creates consistent proportions



### Color-Coded

Color represents a specific measurement for convenient serving



### Perforated & Solid Bottoms

Drain excess liquid from food and spread sauce with ease



### Varying Handle Lengths

Tailor miser lengths to various food pan depths

| CODE   | DESCRIPTION - Measuring spoons         | Pack Size | Capacity   Colour | \$     |
|--------|--|-----------|-------------------|--------|
| 492104 | Measure Miser® Solid Short Handle      | 12        | 30ml   Yellow     | 140.00 |
| 492304 | Measure Miser® Perforated Short Handle | 12        | 30ml   Yellow     | 140.00 |
| 492201 | Measure Miser® Solid Short Handle      | 12        | 45ml   Brown      | 170.00 |
| 492405 | Measure Miser® Solid Short Handle      | 12        | 60ml   Red        | 200.00 |
| 496205 | Measure Miser® Perforated Short Handle | 12        | 60ml   Red        | 200.00 |

# Color Coded Measure Misers®



| CODE   | DESCRIPTION - Measuring spoons                              | Pack Size | Capacity   Colour    | \$     |
|--------|---|-----------|----------------------|--------|
| 492602 | Measure Miser® Solid Short Handle                           | 12        | 90ml   White         | 220.00 |
| 492808 | Measure Miser® Solid Short Handle                           | 12        | 120ml   Forest Green | 225.00 |
| 492908 | Measure Miser® Perforated Short Handle                      | 12        | 120ml   Forest Green | 225.00 |
| 493306 | Measure Miser® Solid Short Handle                           | 12        | 150ml   Beige        | 235.00 |
| 496606 | Measure Miser® Perforated Short Handle - WHILST STOCKS LAST | 12        | 150ml   Beige        | 210.00 |
| 493114 | Measure Miser® Solid Short Handle                           | 12        | 240ml   Blue         | 285.00 |

| CODE   | DESCRIPTION - Measuring spoons                             | Pack Size | Capacity   Colour    | \$     |
|--------|--|-----------|----------------------|--------|
| 396005 | Measure Miser® Solid Long Handle                           | 12        | 60ml   Red           | 190.00 |
| 397002 | Measure Miser® Solid Long Handle - WHILST STOCKS LAST      | 12        | 90ml   White         | 166.00 |
| 398008 | Measure Miser® Solid Long Handle                           | 12        | 120ml   Forest Green | 195.00 |
| 399003 | Measure Miser® Solid Long Handle                           | 12        | 180ml   Black        | 250.00 |
| 399103 | Measure Miser® Perforated Long Handle - WHILST STOCKS LAST | 12        | 180ml   Black        | 220.00 |
| 399214 | Measure Miser® Solid Long Handle                           | 12        | 240ml   Blue         | 310.00 |

Measure Miser® Solid Short Handle - 492104



Measure Miser® Perforated Short Handle - 496205



Measure Miser® Perforated Long Handle - 398108





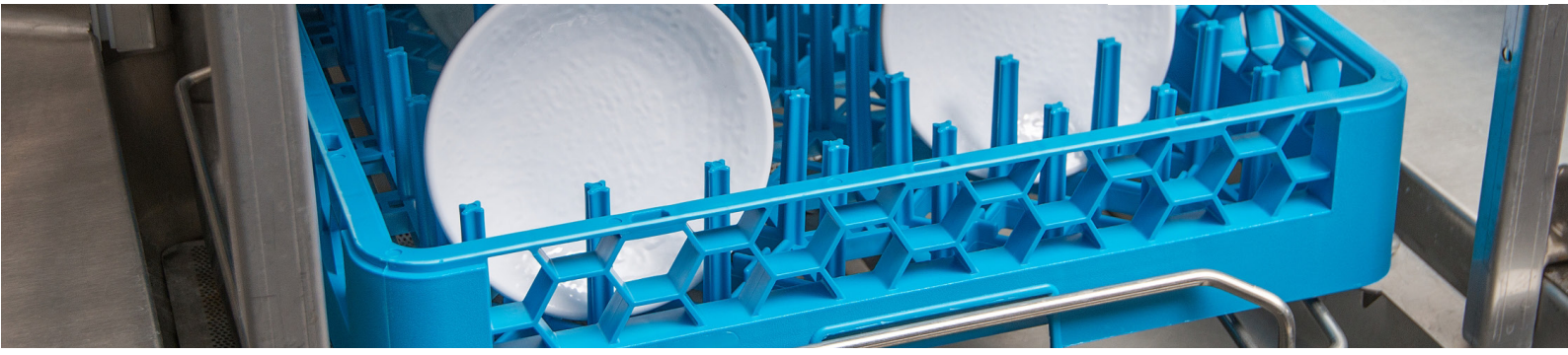

## Clean Rack. Clean Dishes

From the most fragile tableware to heavy-duty kitchen items such as utensils and cutlery, OptiClean Dish Racks offer the safest sanitary cleaning option. OptiClean Racks are engineered to flow. The honeycomb design ensures durability and the open wall ensures a free flow of water and soap. Wash, dry and hold with OptiClean Dish Racks.



## Benefits

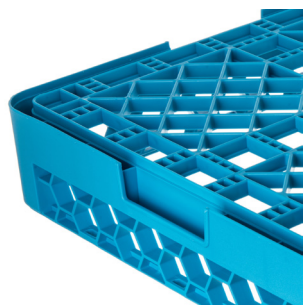
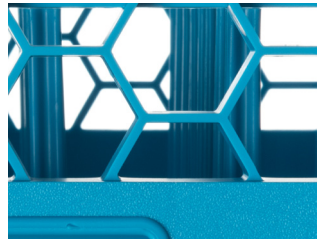

### Honeycomb Design

Ensures durability, weight dispersion and the free flow of water and soap.

### Rounded Edges

Discourages clinging food particles and releases dirty water

### Secure Universal Stacking

Ensures a smooth transition to Carlisle washracks from other industry racks without

### Comfort Curve Handles

Comfortable carrying on all four sides of rack

| CODE  | DESCRIPTION  | Pack Size | \$ EA |
|-------|--|-----------|-------|
| RP14  | OptiClean™ All-Purpose Peg Dish Rack; Colour Blue; Open design for even and thorough washing, drying & draining; 500L x 500W x 102Hmm; Peg height 63mm; Space between pegs 45mm          | 1         | 48.00 |
| ROP14 | OptiClean™ Open Side All-Purpose Peg Dish Rack Colour Blue; Open design for even and thorough washing, drying & draining; 500L x 500W x 102Hmm; Peg height 76mm; Space between pegs 45mm | 1         | 69.00 |
| RTP14 | OptiClean™ Open Bowl Rack Colour Blue; Open design for even and thorough washing, drying & draining; 500L x 500W x 102Hmm; Space between pegs 45mm                                       | 1         | 49.00 |
| RB14  | OptiClean™ Open Bowl Rack Colour Blue; Open design for even and thorough washing, drying & draining; 500L x 500W x 102Hmm  | 1         | 38.00 |

# OptiClean Dish Racks

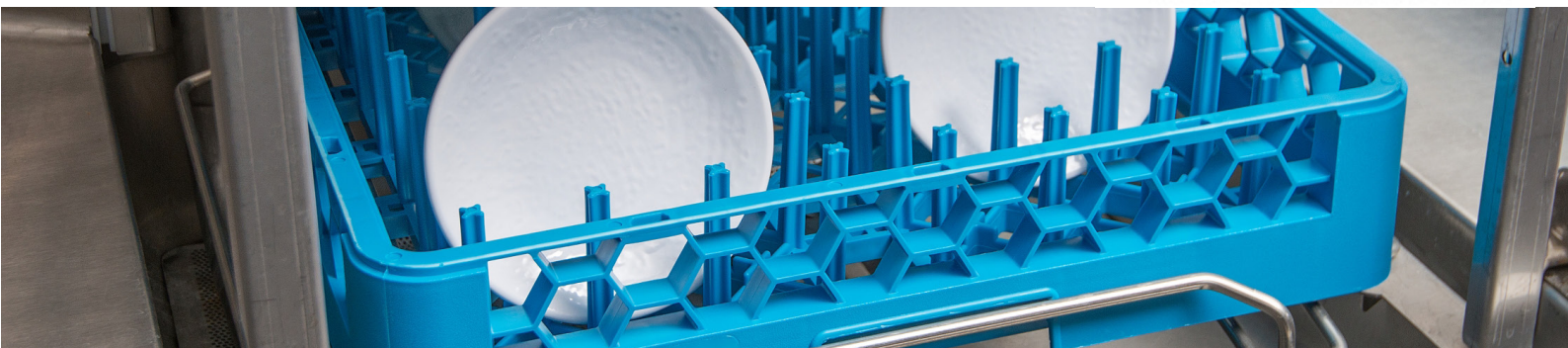

| CODE     | DESCRIPTION   | Pack Size | \$ EA  |
|----------|---|-----------|--------|
| RF14     | OptiClean™ Flatware Rack; Colour Blue;<br>Open design for even and thorough washing, drying & draining; 500L x 500W x 102Hmm; 464mm compartment Tight enough to keep small items contained  | 1         | 42.00  |
| RFP14    | OptiClean™ Food Pan or Insulated-Meal-Delivery- Tray Rack; Colour Blue;<br>Open design for even and thorough washing, drying & draining; 500L x 500W x 102Hmm;  | 1         | 180.00 |
| RC20-114 | OptiClean™ 20 Compartment Divided Rack with one open extender;<br>Colour Blue; 500L x 500W x 140Hmm with extender; Compartment 120mm depth x 110L x 87Wmm<br>Open Tilted Design – Compartments hold cups in a tilted position, promoting even and thorough washing, drying and draining | 1         | 58.00  |
| RG25-114 | OptiClean™ 25 Compartment Divided Rack with one 25 compartment divided extender; Colour Blue; 500L x 500W x 140Hmm with extender; Compartment 120mm depth x 90L x 90Wmm   | 1         | 70.00  |
| RG36-114 | OptiClean™ 36 Compartment Divided Rack with one 36 compartment divided extender; Colour Blue; 500L x 500W x 140Hmm with extender; Compartment 120mm depth x 74L x 74Wmm   | 1         | 70.00  |
| RG49-114 | "OptiClean™ 49 Compartment Divided Rack with one 49 compartment divided extender; Colour Blue; 500L x 500W x 140Hmm with extender; Compartment 120mm depth x 60L x 60Wmm"   | 1         | 56.00  |
| C32P214  | "Perma-Sil™ 8-Compartment Dishwash Cutlery Storage Basket;<br>Colour Blue; Open weave basket design for optimum air and water flow for efficient washing & drying; 433L x 197W x 175Hmm; Compartment 90L x 90Wmm"   | 1         | 60.00  |
| RE2514   | "OptiClean™ 25-Compartment Divided Rack Extender<br>Colour Blue; 500L x 500W x 45Hmm; Compartment 90L x 90Wmm"  | 1         | 19.00  |
| RE3614   | "OptiClean™ 36-Compartment Divided Rack Extender<br>Colour Blue; 500L x 500W x 45Hmm; Compartment 74L x 74Wmm"  | 1         | 19.00  |
| C223614  | "E-Z Glide™ Warewashing Rack Dolly Without Handle;<br>Wt Capacity 150 kg; Holds any std 500mm racks;<br>Colour Blue; 572L x 572W x 203Hmm"  | 1         | 320.00 |
| C223703  | E-Z Glide™ Handle for C223614; Colour Black; Material Steel   | 1         | 400.00 |
| RDC07    | "OptiClean™ Dust Cover for ware washing racks Colour – Clear;<br>533L x 533W x 914Hmm"  | 1         | 135.00 |





# Product Holding Units

Two year parts and labour warranty

## 5 Reasons to choose Duke Hot Holding

1. Ultimate Holding Environment
2. Broad Menu Flexibility
3. Intuitive Touchscreen
4. Recipe Management
5. Built-in Connectivity

**Warranty:**  
2 year onsite  
parts and labour



| CODE            | DESCRIPTION                                       | Pans | Lids      | Amp | \$    |
|-----------------|---|------|-----------|-----|-------|
| RFHU-22-DL042GM | Duke hot hold cabinet, 2 high 2 wide, 65mm deep   | 4    | Dedicated | 10  | 9125  |
| RFHU-22-DL044GM | Duke hot hold cabinet, 2 high 2 wide, 100mm deep  | 4    | Dedicated | 10  | 10015 |
| RFHU-23-FL034GM | Duke hot hold cabinet, 2 high, 3 wide, 100mm deep | 6    | Flexi     | 10  | 11340 |
| RFHU-24-FL042GM | Duke hot hold cabinet, 2 high, 4 wide, 65mm deep  | 8    | Flexi     | 10  | 12000 |
| RFHU-24-DL082GM | Duke hot hold cabinet, 2 high, 4 wide, 65mm deep  | 8    | Dedicated | 10  | 12000 |
| RFHU-24-FL044GM | Duke hot hold cabinet, 2 high, 4 wide, 100mm deep | 8    | Flexi     | 10  | 13335 |
| RFHU-24-DL084GM | Duke hot hold cabinet, 2 high, 4wide, 100mm deep  | 8    | Dedicated | 10  | 13335 |
| RFHU-32-FL034GM | Duke hot hold cabinet, 3 high, 2 wide, 100mm deep | 6    | Flexible  | 10  | 13335 |

Order pans separately

## PANS FOR USE IN CABINETS - save \$\$ with the 12 pack

| CODE      | DESCRIPTION                               | \$ each | \$ 12 pack |
|-----------|---|---------|------------|
| 30860HH13 | Double Handled Amber Pans, 1/3 size, 64mm | 75      | 860        |
| 30860H13  | Single Handled Amber Pans, 1/3 size, 64mm | 73      | 840        |
| 10420B13  | Half Size Amber Pan, 1/2 size, 64mm       | 58      | -          |
| 10400B13  | Full Size Amber Pan, full size, 64mm      | 115     | -          |

| CODE      | DESCRIPTION                                | \$ each | \$ 12 pack |
|-----------|--|---------|------------|
| 30861HH13 | Double Handled Amber Pans, 1/3 size, 102mm | 88      | 1008       |
| 30861H13  | Single Handled Amber Pans, 1/3 size, 102mm | 86      | 985        |
| 10421B13  | Half Size Amber Pan, 1/2 size, 102mm       | 76      | -          |
| 10401B13  | Full Size Amber Pan, full size, 102mm      | 142     | -          |

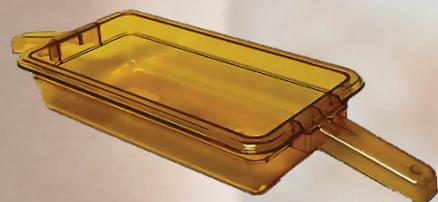

Double Handle Pan for pass-through operations



# Product Holding Units

Two year parts and labour warranty

## Accessories

#1092-0569K

Stainless Steel RFHU Solid Lid  
w/o pan guide (Flexible Unit)

**LIST PRICE EA 120**



#1092-0570K

Stainless Steel RFHU Solid Lid  
w pan guide (Flexible Unit)

**LIST PRICE EA 125**



#169769

Duke GN Half Long Pan  
63mm deep Amber high heat

**LIST PRICE EA 159**

#217530

Duke GN Half Long Pan  
102mm deep Amber high heat

**LIST PRICE EA 198**



#1092-0571K

Stainless Steel RFHU Ventid Lid  
w/o pan guide (Flexible Unit)

**LIST PRICE EA 150**



#1092-0572K

Stainless Steel RFHU Ventid Lid  
w pan guide (Flexible Unit)

**LIST PRICE EA 165**



#1092-0568

Stainless Steel RFHU Cover Fixed  
(Dedicated Unit)

**LIST PRICE EA 105**



#3087013

Plastic 1/3 size trivet  
*Fried Product*

**LIST PRICE EA 28**



#1043513

Plastic 1/2 size trivet  
*Fried Product*

**LIST PRICE EA 36**



#217514

Stainless Steel 1/3 size trivet  
*Fried Product*

**LIST PRICE EA 36**



#165844

Half Size Pan Carrier

**LIST PRICE EA 81**



#158368

Full Size Pan Trivet

**LIST PRICE EA 208**

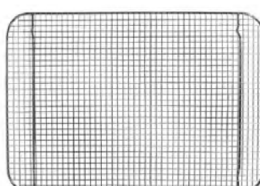





# Product Holding Units

Two year parts and labour warranty

The Duke ReadyFlex™ Hot Holding Cabinets delivers outstanding food quality. The food is always hot, fresh and ready to serve where and when you need it. Change your recipes and hold configurations from breakfast to lunch to dinner with easy to learn touchscreens. The built in Wi-Fi, Ethernet and Bluetooth connectivity means ReadyFlex is ready to connect through the Duke Connected Equipment Platform. Speak with the sales team about all the options and features available.

## Standard Size

64mm Deep Pan Model

102mm Deep Pan Model



RFHU-22



RFHU-23



RFHU-24



RFHU-32



RFHU-34

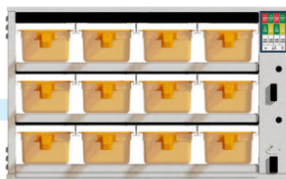

RFHU-41



RFHU-42



**A configuration to fit any space!**

No matter what size space you have and what volume of food you need to maintain, there is a ReadyFlex configuration for you. ReadyFlex is stackable and easy to fit into your lineup.



### Standard vs. Full

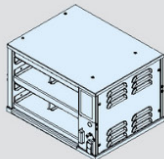

STANDARD  
RFHU-22

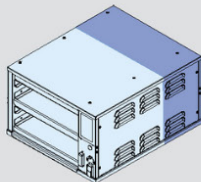

FULL  
RFHU-21F



# Product Holding Units

Two year parts and labour warranty

## NEW configuration options

### Full Size

Hybrid models have both 64mm and 102mm depths available in the same full size unit.

64mm Deep Pan Model

102mm Deep Pan Model

Hybrid Model

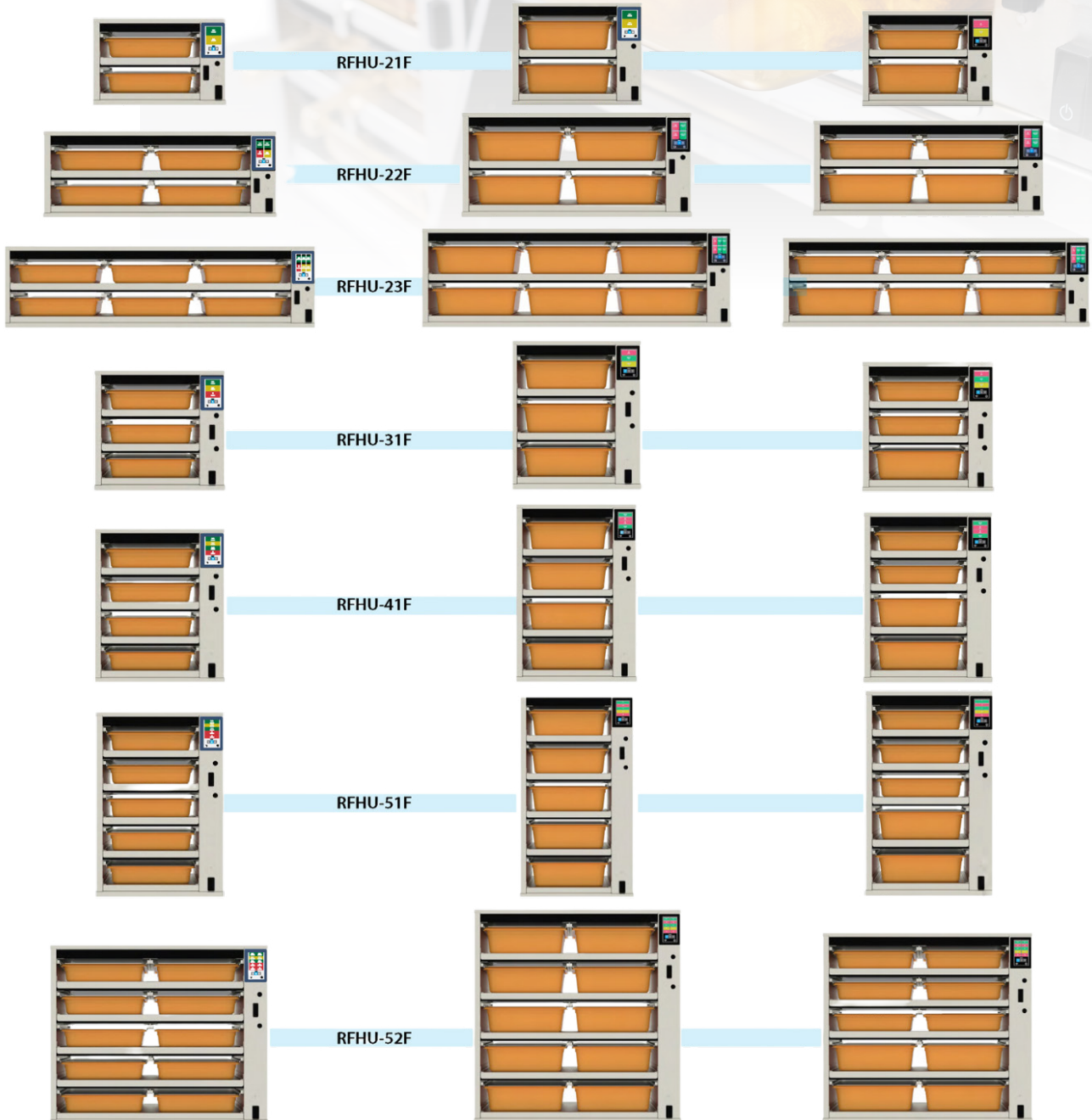





## DYNAMIC

### A NEW DYNAMIC® WAY TO PREPARE FOOD

**Since creating the commercial mixer in 1964, Dynamic has continued to develop and create an entire range of culinary preparation devices, used in professional kitchens throughout the world.**

Knowledge and experience have brought great notoriety to our company. As well as being the specialist producer of commercial mixers,

DYNAMIC is also the manual salad spinners creator and offers a large range of manual food cutters.

French manufacturer, we have total control over all aspects of production which guarantee reliable, robust and high quality products.



- UP TO 300 KG PER HOUR
- SUITABLE FOR 400 COVERS PER SERVICE

**3 in 1**

# COMBINED 3-in-1

## TABLE TOP ELECTRIC VEGETABLE SLICER, FOOD PROCESSOR AND BLEND & MIX

- HYGENIC DESIGN
- DISHWASHER SAFE
- HANDLE EASY CLIP
- QUICK TOOL FREE ASSEMBLY AND DISASSEMBLY
- POWERFUL ASYNCHRONOUS MOTOR FOR INTENSIVE USE



Cylindrical hopper for more precision (zucchini, cucumber ...)

Large hopper for more productivity and bulky vegetables (cabbage & lettuce)

Space saving, side ejection

Excellent stability, metal engine base

**VARIABLE SPEED**  
control panel



REGISTERED MODEL

DELIVERED WITH STANDARD KNIFE



CAPACITY : 5.4 LITRES

|                               |                    |
|-------------------------------|--------------------|
| Vegetable Slicer Speed R.P.M. | 320 to 720 R.P.M.  |
| Food Processor Speed R.P.M.   | 350 to 3500 R.P.M. |
| Functions                     | Pulse & Reverse    |
| Output                        | 1100 W             |
| Item code                     | CL322              |

✓ **STAINLESS STEEL & METAL MOTOR BASE**

**LIST PRICE \$6850**

# VEGETABLE SLICER



## VEGETABLE SLICER

**1 SPEED**  
control panel

|              |            |
|--------------|------------|
| Speed R.P.M. | 320 R.P.M. |
| Functions    | -          |
| Speed        | 1 speed    |
| Output       | 1100 W     |
| Item code    | CL100      |

**LIST PRICE \$3795**



*The essential tool for smooth and modified structure preparations, raw or cooked.*

The BLEND&MIX keeps all the nutritional and taste qualities of the food intact, as well as the organoleptic properties.

People suffering from chewing problems can keep the pleasure of enjoying a varied and tasty diet.

The Blend & Mix from Dynamic is the essential partner for collective kitchens (nursing homes, hospitals, schools, etc...)!



- FROM 100G TO 4KG
- SUITABLE FOR 20 TO 100 COVERS PER SERVICE

# TABLE TOP FOOD PROCESSOR

MIX, EMULSIFYING, BLENDING AND CHOPPING IN A FEW SECONDS

CAPACITY : 5.4 LITRES



DELIVERED WITH STANDARD KNIFE



## FOOD PROCESSOR 1 SPEED

control panel

Speed R.P.M. 1500 R.P.M.

Functions -

Speed 1 speed

Output 1100 W

Item code CL200

**LIST PRICE \$3995**



## ACCESSORIES



### Smooth knife



To prepare fine stuffing and mousselines, minced meats, sauces, emulsions, butters, duxelles, smooth and modified textures on baked products.

STANDARD KNIFE CL8001



### Serrated knife



To smooth pasta, knead, grind, make pralines, mix spices.

CL8002



### Micro-serrated knife



To chop herbs, smooth and modified textures on raw products.

CL8003

# ACCESSORIES available separately



## Slicing disc

**LIST PRICE \$265 EA**

Item code

|               |               |
|---------------|---------------|
| <b>CL1005</b> | <b>0,5 mm</b> |
| <b>CL1015</b> | <b>1,5 mm</b> |
| <b>CL1025</b> | <b>2,5 mm</b> |
| <b>CL1030</b> | <b>3 mm</b>   |
| <b>CL1040</b> | <b>4 mm</b>   |
| <b>CL1050</b> | <b>5 mm</b>   |
| <b>CL1070</b> | <b>7 mm</b>   |
| <b>CL1080</b> | <b>8 mm</b>   |
| <b>CL1090</b> | <b>9 mm</b>   |
| <b>CL1110</b> | <b>11 mm</b>  |
| <b>CL1120</b> | <b>12 mm</b>  |
| <b>CL1130</b> | <b>13 mm</b>  |

## Julienne disc

**LIST PRICE \$370 EA**

Item code

|                      |                 |
|----------------------|-----------------|
| <b>CL3032 CL3042</b> | <b>3x2 mm</b>   |
| <b>CL3044 CL3055</b> | <b>4x2 mm</b>   |
| <b>CL3052 CL3088</b> | <b>4x4 mm</b>   |
| <b>CL3010</b>        | <b>5x5 mm</b>   |
|                      | <b>5x2 mm</b>   |
|                      | <b>8x8 mm</b>   |
|                      | <b>10x10 mm</b> |



## Grating disc

**LIST PRICE \$220 EA**

Item code

|               |             |
|---------------|-------------|
| <b>CL2002</b> | <b>2 mm</b> |
| <b>CL2003</b> | <b>3 mm</b> |
| <b>CL2005</b> | <b>5 mm</b> |
| <b>CL2009</b> | <b>9 mm</b> |

## Dicing grid

**LIST PRICE \$550 EA**

Item code

|               |                 |
|---------------|-----------------|
| <b>CL4008</b> | <b>8x8 mm</b>   |
| <b>CL4010</b> | <b>10x10 mm</b> |

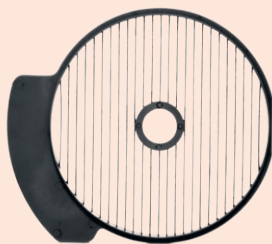

## French fries grid

**LIST PRICE \$570 EA**

Item code **CL5008**

**8x8 mm**

## Disc support

**LIST PRICE \$38 EA**

Adjustable unit table or wall disc support

Item code

**CL7000**





PROFESSIONAL SERIES  
**DYNAMIX®**

**ESPECIALLY DESIGNED FOR SMALL PREPARATIONS, SAUCES AND EMULSIONS. DYNAMIX®**



**ACCESSORIES**

Accessories available separately.

Removable whisks for easy cleaning

**EXTRACTABLE WHISKS**

**EXCLUSIVE PRODUCT**

185 mm

126 mm

Designation  
**Whisk Dynamix®**

Designation  
**Ricer tool**

Speed R.P.M. 600 / 2 500  
Item code DYN-AC516

70 / 300  
DYN-AC517

**LIST PRICE \$340 \$500**



Reverse sharpened blades

**EXCLUSIVE PRODUCT**

160 mm

Designation  
**Cutter Bowl Dynamix®**

Designation  
**Blender Dynamix®**

Speed R.P.M. 600 / 2 500  
Item code DYN-AC518

3 000 / 13 000  
DYN-AC560

**LIST PRICE \$485 \$390**



160 mm



190 mm

Designation  
**Dynamix® MX050**

|                   |                |
|-------------------|----------------|
| Knife             | 2 Blades       |
| Output            | 220 W          |
| Total length      | 395 mm         |
| Shaft length      | 160 mm         |
| Bell diameter     | 55 mm          |
| Diameter          | 70 mm          |
| Weight / Packaged | 1 Kg / 1,2 Kg  |
| Speed R.P.M.      | 3 000 / 13 000 |
| Item code         | DMX160         |

Designation  
**Dynamix® MX090**

|                   |                |
|-------------------|----------------|
| Knife             | 4 Blades       |
| Output            | 250 W          |
| Total length      | 425 mm         |
| Shaft length      | 190 mm         |
| Bell diameter     | 66 mm          |
| Diameter          | 70 mm          |
| Weight / Packaged | 1 Kg / 1,5 Kg  |
| Speed R.P.M.      | 3 000 / 13 000 |
| Item code         | DMX190         |

**LIST PRICE \$490 \$595**



**MIXERS**



**BLENDER (SOUP)**



**WHISKS**



**FOODMILL RICER TOOL**



**CUTTER**

PROFESSIONAL  
SERIES  
**JUNIOR**

**THE LIGHTEST MIXER ON THE  
MARKET IN ITS CATEGORY.**

|                   |               |
|-------------------|---------------|
| Designation       | <b>MX020</b>  |
| Knife             | 2 Blades      |
| Output            | 270 W         |
| Total length      | 505 mm        |
| Shaft length      | 225 mm        |
| Diameter          | 94 mm         |
| Weight / Packaged | 1,7 Kg / 2 Kg |
| Speed R.P.M.      | 12 000        |
| Item code         | MX225         |

**LIST PRICE \$865**



Designation  
**MX021.V**

|                   |               |
|-------------------|---------------|
| Knife             | 2 Blades      |
| Output            | 270 W         |
| Total length      | 505 mm        |
| Shaft length      | 225 mm        |
| Diameter          | 94 mm         |
| Weight / Packaged | 1,7 Kg / 2 Kg |
| Speed R.P.M.      | 12 000        |
| Item code         | DMX225        |

**LIST PRICE \$1115**



Designation  
**MX024**

|                   |                 |
|-------------------|-----------------|
| Knife             | 2 Blades        |
| Output            | 270 W           |
| Total length      | 580 mm          |
| Shaft length      | 300 mm          |
| Diameter          | 94 mm           |
| Weight / Packaged | 1,9 Kg / 2.2 Kg |
| Speed R.P.M.      | 12 000          |
| Item code         | DMX300          |

**LIST PRICE \$1215**



**CONVENIENCE**

Wall support included  
Item code 089959



# ACCESSORIES

Accessories available separately.



MIXERS



BLENDER  
(SOUP)



WHISKS



FOODMILL  
RICER TOOL



CUTTER

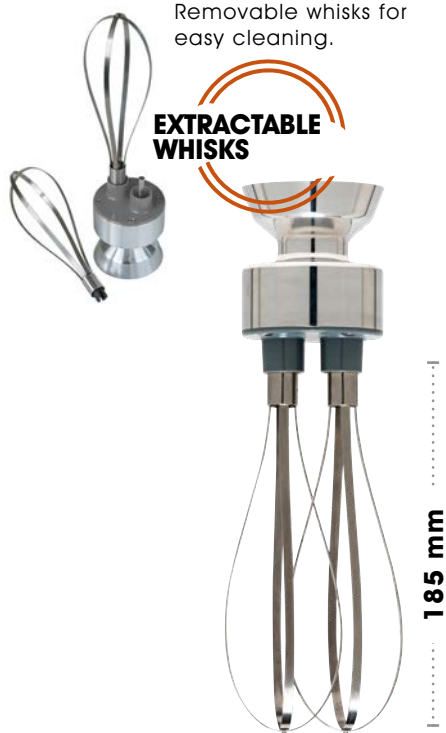

Designation  
**Whisk Junior**

Speed R.P.M. 600 / 2 500  
Item code DYN-AC102

**LIST PRICE \$590**



Designation  
**Ricer tool Junior**

70 / 300  
DYN-AC103

**\$595**



Designation  
**Cutter Bowl Junior**

600 / 2 500  
DYN-AC104

**\$550**

## CONVENIENCE

Wall support included  
Item code 0880.1

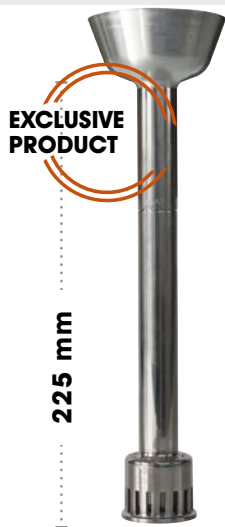

Designation  
**Blender Junior**

3 000 / 12 000  
DYN-AC066

**LIST PRICE \$460**





PROFESSIONAL  
SERIES  
**SENIOR**

350 W  
20 / 40 L



**CONVENIENCE**

Wall support included  
Item code 089959



**EXCLUSIVE  
PRODUCT**

Stainless steel perforated grid and blade can easily be dismantled for cleaning.



**AN EXCELLENT  
CHOICE FOR  
TRADITIONAL  
AND COLLECTIVE  
CATERING.**

Designation  
**MX016**

|                   |                 |
|-------------------|-----------------|
| Knife             | 3 Blades        |
| Output            | 350 W           |
| Total length      | 740 mm          |
| Shaft length      | 400 mm          |
| Diameter          | 97 mm           |
| Weight / Packaged | 2,5 Kg / 2,9 Kg |
| Speed R.P.M.      | 9 500           |
| Item code         | DMX400          |

**LIST PRICE \$1485**



**QUICK ASSEMBLY**

**DETACHABLE**



Variable speed  
Optional

400 mm



Designation  
**Whisk Senior**  
300 / 900  
DYN-AC007

**LIST PRICE \$635**

420 mm



Designation  
**Ricer tool Senior**  
100 / 600  
DYN-AC004



Designation  
**Cutter Bowl inox Senior**  
400 / 1 500  
DYN-AC055

**LIST PRICE**

**\$1265**

**\$1315**

PROFESSIONAL  
SERIES  
**MASTER**

600 W  
40 / 100 L



Variable  
speed  
Optional



410 mm



Clean<sup>up</sup>  
System



Variable  
speed  
Optional



Monoblock  
Removable bell

410 mm

Designation  
**MX003.HC**

|                   |                 |
|-------------------|-----------------|
| Knife             | 3 Blades        |
| Output            | 600 W           |
| Total length      | 720 mm          |
| Shaft length      | 410 mm          |
| Diameter          | 122 mm          |
| Weight / Packaged | 3,7 Kg / 4,1 Kg |
| Speed R.P.M.      | 9 500           |
| Item code         | DMX410C         |

Designation  
**MX005.V**

|                   |                 |
|-------------------|-----------------|
| Knife             | 3 Blades        |
| Output            | 600 W           |
| Total length      | 715 mm          |
| Shaft length      | 410 mm          |
| Diameter          | 110 mm          |
| Weight / Packaged | 3,4 Kg / 3,8 Kg |
| Speed R.P.M.      | 9 500           |
| Item code         | MX91-410        |



**CONVENIENCE**

Wall support included  
Item code 0881

**LIST PRICE \$1730**

**\$1665**

# PROFESSIONAL SERIES MASTER

Designation  
**MX160**

|                   |               |
|-------------------|---------------|
| Knife             | 3 Blades      |
| Output            | 600 W         |
| Total length      | 628 mm        |
| Shaft length      | 300 mm        |
| Diameter          | 122 mm        |
| Weight / Packaged | 3.7 Kg / 4 Kg |
| Speed R.P.M.      | 9 500         |
| Item code         | DMX300 CC     |

**Detachable**

**NEW BRATT PAN MODEL**

**LIST PRICE \$1650**



Designation  
**MX012**

|                   |                 |
|-------------------|-----------------|
| Knife             | 3 Blades        |
| Output            | 600 W           |
| Total length      | 810 mm          |
| Shaft length      | 500 mm          |
| Diameter          | 122 mm          |
| Weight / Packaged | 3.9 Kg / 4.3 Kg |
| Speed R.P.M.      | 9 500           |
| Item code         | DMX500          |

**Detachable**

**LIST PRICE \$1770**



**EXTRACTABLE  
WHISKS**

Removable whisks  
or easy cleaning.



245 mm

Designation  
**Whisk Master**

|              |           |
|--------------|-----------|
| Speed R.P.M. | 300 / 900 |
| Item code    | DYN-AC003 |

**LIST PRICE \$710**

Stainless  
steel perforated  
grid and blade  
can easily be  
dismantled for  
cleaning.

**EXCLUSIVE  
PRODUCT**

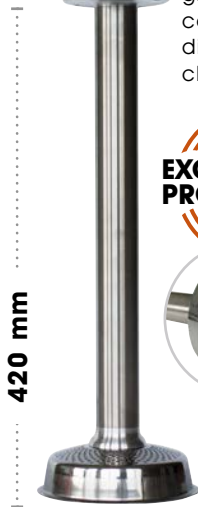

420 mm

Designation  
**Ricer tool Master**

|              |           |
|--------------|-----------|
| Speed R.P.M. | 100 / 600 |
| Item code    | DYN-AC004 |

**\$1265**

**EXCLUSIVE  
PRODUCT**



410 mm

Designation  
**Blender Master**

|           |           |
|-----------|-----------|
| Item code | DYN-AC070 |
|-----------|-----------|

**\$910**

## DETACHABLE EQUIPMENT ACCESSORIES

Accessories available separately.



# ACCESSORIES

Accessories available separately.



MIXERS



BLENDER  
(SOUP)



WHISKS



FOODMILL  
RICER TOOL



CUTTER

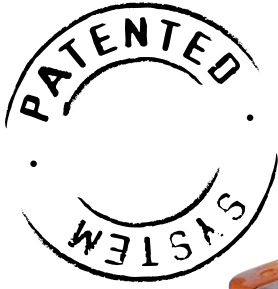

Designation

## Cutter Bowl Master

A selection of knives (standard or serrated)

Speed R.P.M. 400 / 1500

Item code DYN-AC055

**LIST PRICE \$1315**

Clean<sup>UP</sup> System

## FULLY REMOVABLE MIXER FOOT AND BELL

For easy cleaning, maintenance and perfect hygiene. All stainless steel for increased durability of your attachment. Dishwasher proof. **This DYNAMIC exclusive system complies with HACCP requirements.**



## CONVENIENCE

Wall support included  
Item code 0880



WHISKS



420 mm

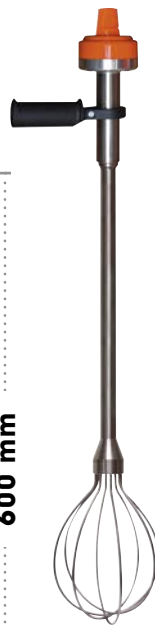

600 mm

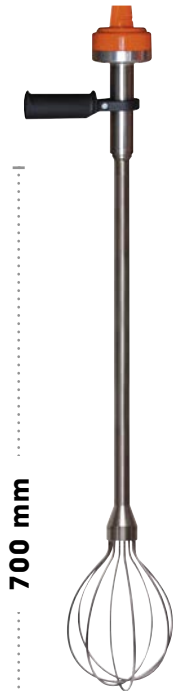

700 mm

Designation

**FM420**

**FM600**

**FM700**

Speed R.P.M.

100 / 600

100 / 600

100 / 600

Item code

DYN-AC202

DYN-AC200

DYN-AC201

**LIST PRICE**

**\$1225**

**\$1270**

**\$1300**

PROFESSIONAL  
SERIES

**SMX**

-  
MONOBLOCK /  
DETACHABLE EQUIPMENT

**850 / 1000 W**

**75 / 300 L**



## ADVANTAGES

- **Performance:** Special tool for a smooth mix.
- **Robustness:** Stainless steel foot.
- **Hygiene:** Completely removable foot and bell without tools.  
Tube and bell 100% stainless steel for easy cleaning.
- **Comfort:** Easy use thanks to its support.
- **Safety:** Unlocking safety feature.
- **Output:** New motorisation for a better output.

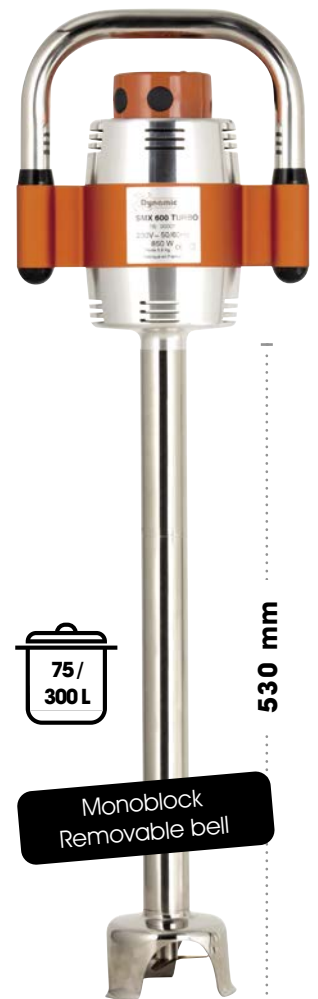

Designation  
**MX002T**

|                   |                 |
|-------------------|-----------------|
| Knife             | 3 Blades        |
| Output            | 850 W           |
| Total length      | 800 mm          |
| Shaft length      | 530 mm          |
| Diameter          | 125 mm          |
| Weight / Packaged | 6,1 Kg / 7,7 Kg |
| Speed R.P.M.      | 11 000          |
| Item code         | SMX600T         |

**LIST PRICE \$2450**

# SMX SERIES

Special production kitchens and intensive use.

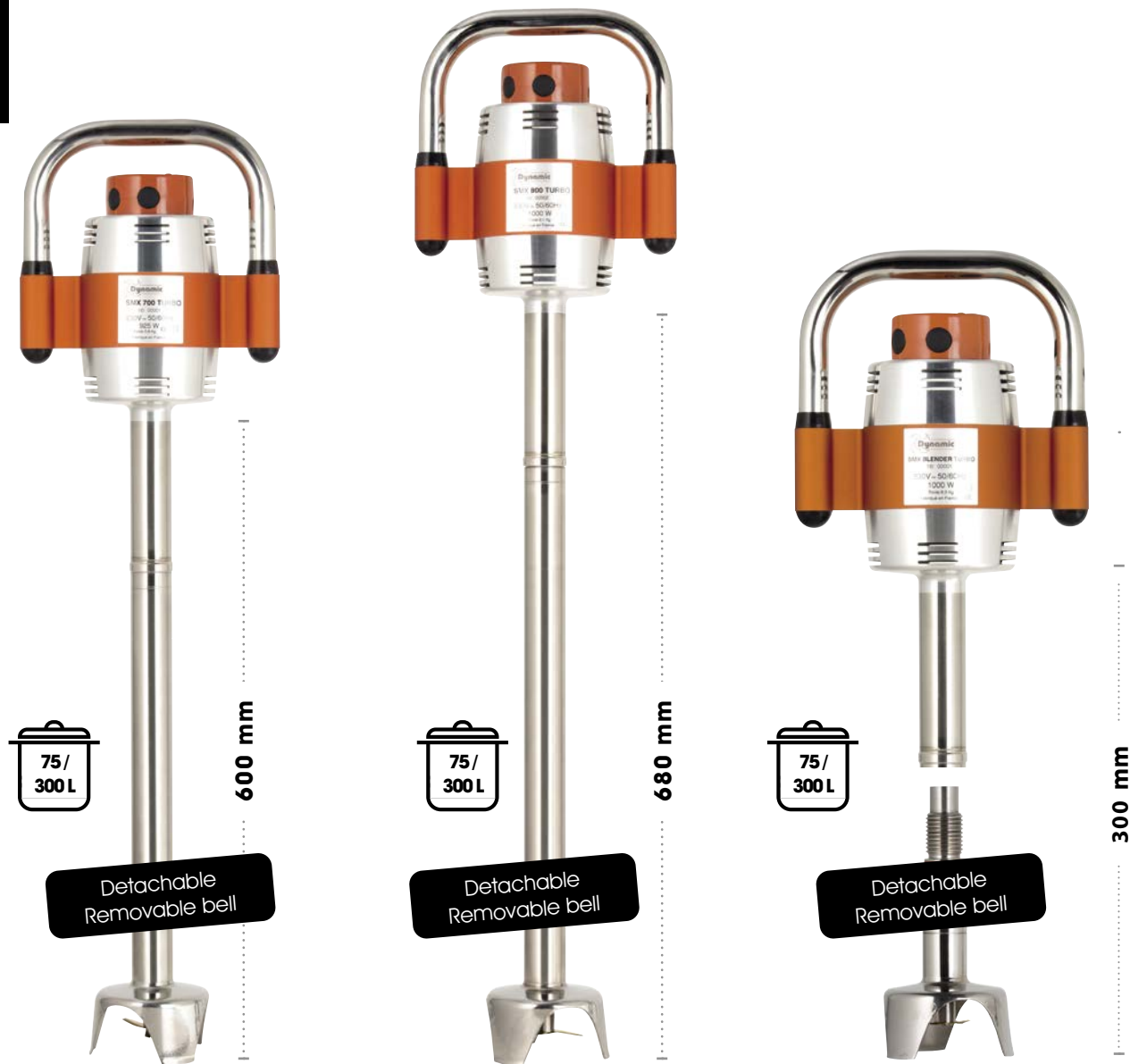

Designation  
**MX040T**

|                   |                 |
|-------------------|-----------------|
| Knife             | 3 Blades        |
| Output            | 925 W           |
| Total length      | 870 mm          |
| Shaft length      | 600 mm          |
| Diameter          | 125 mm          |
| Weight / Packaged | 6,5 Kg / 8,0 Kg |
| Speed R.P.M.      | 11 000          |
| Item code         | SMX700T         |

**LIST PRICE \$3040**

Designation  
**MX001T**

|                   |                 |
|-------------------|-----------------|
| Knife             | 3 Blades        |
| Output            | 1000 W          |
| Total length      | 960 mm          |
| Shaft length      | 680 mm          |
| Diameter          | 125 mm          |
| Weight / Packaged | 6,7 Kg / 8,2 Kg |
| Speed R.P.M.      | 11 000          |
| Item code         | SMX800T         |

**\$3340**

Designation  
**MX150T**

|                   |                 |
|-------------------|-----------------|
| Hammer            | 3 Blades        |
| Output            | 1000 W          |
| Total length      | 609 mm          |
| Shaft length      | 300 mm          |
| Diameter          | 125 mm          |
| Weight / Packaged | 5,9 Kg / 8,0 Kg |
| Speed R.P.M.      | 11 000          |
| Item code         | SMX300CC        |

**\$3650**



# PROFESSIONAL SERIES SMX

## ACCESSORIES

Accessories available separately.

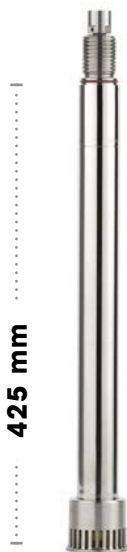

425 mm

### CONVENIENCE

Wall support included  
Item code 0862

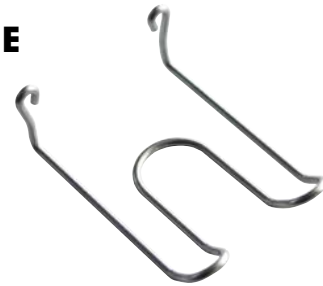

Designation  
**Blender SMX  
Turbo**  
11 000  
DYN-AC072T

**LIST PRICE \$1250**

## ACCESSORIES

# OUR SUPPORTS

MASTER SERIES  
SMX SERIES

### SAY STOP TO MUSCULOSKELETAL DISORDERS

with this hook allowing enhanced manoeuvrability of your large mixers. This hook support is placed directly on the rim of the pot.

The SM020 Mixer hook support is standardly supplied for each detachable version MASTER & SMX SERIES.



### PAN SUPPORT BRACKETS

For your safety and your comfort.

| Weight               | 1,9 Kg       | 2,3 Kg       | 2,6 Kg       | 2,8 Kg       | 3,2 Kg       |                               |
|----------------------|--------------|--------------|--------------|--------------|--------------|-------------------------------|
| Diameter of the pot* | 400 mm       | 600 mm       | 800 mm       | 1000 mm      | 1200 mm      |                               |
| Item code DYN:       | <b>SM001</b> | <b>SM002</b> | <b>SM003</b> | <b>SM004</b> | <b>SM005</b> | * Maximum diameter of the pot |
| <b>LIST PRICE</b>    | <b>\$635</b> | <b>\$675</b> | <b>\$685</b> | <b>\$695</b> | <b>\$730</b> |                               |

PROFESSIONAL SERIES

# SALAD SPINNERS

MANUAL & ELECTRIC  
5 / 20 L

## ADVANTAGES

- **Hygiene:** Anti-bacterial incorporated, complies with HACCP requirements.
- **Comfort:** 100% watertight to avoid water leakage.
- **Performance:** Intensive use.
- **Robustness:** Gear with a stainless steel pin incorporated.



**WITH TIMEOUT**  
(RUNNING TIME 1 MINUTE)  
Item code E003.T

Anti-bacterial incorporated



**E10 Manual\***

**E20 Manual\***

**E20 SC Manual\***  
Sealed cover

**EM98 Electric**

|                     |                     |                     |                     |
|---------------------|---------------------|---------------------|---------------------|
| 330 mm              | 430 mm              | 430 mm              | 430 mm              |
| 420 mm              | 500 mm              | 500 mm              | 630 mm              |
| -                   | -                   | -                   | 200W                |
| -                   | -                   | -                   | 500                 |
| 2 - 3 lettuce heads | 3 - 5 lettuce heads | 3 - 5 lettuce heads | 3 - 5 lettuce heads |
| 2,4 Kg / 3,0 Kg     | 3,6 Kg / 4,8 Kg     | 3,6 Kg / 4,8 Kg     | 8,3 Kg / 10 Kg      |
| E001                | E002                | E004                | E003                |

**LIST PRICE E10 \$320**

**E20 \$360**

**E20 SC \$420**

**EM98 \$1265**



Base with suction pads  
For enhanced stability.  
(only for E20 models).

**LIST PRICE \$155 (DYN-AC019)**

|                                 |           |
|---------------------------------|-----------|
| Designation                     | Item code |
| Stabilising base E20 & E20 SC   | DYN-AC019 |
| Set of gears for both E10 - E20 | 2815.1    |
| Set of gears E20 SC             | 2815.2    |





# GIGAMIX SERIES

## STANDARD VERSION

Ref : TB001 - without variable speed control

Ref : TB002 - with variable speed control

Option : factory installed only



SPECIAL PRODUCTION KITCHENS,  
FOR HEAVY-DUTY MIXING.



### TECHNICAL DATA

|                               |  |
|-------------------------------|--|
| OUTPUT MAX                    | 2.2 KW                                 |
| SPEED                         | 2800 to 4000 R.P.M.                    |
| VOLTAGE                       | 400 V three-phase with neutral, 50 Hz* |
| MINIMUM HEIGHT - under bell - | 500 mm                                 |
| MAXIMUM HEIGHT - under bell - | 790 mm                                 |
| SHAFT LENGTH                  | 570 mm                                 |
| DIAMETER BELL                 | 270 mm                                 |
| ACTUAL WEIGHT                 | 79 kg                                  |

\*Other voltages on request.

**LIST PRICE \$22995 TB001**  
**\$28995 TB002**

## DESCRIPTION

- Designed for high volumes, works directly in pots.
- Offers long service lifetime for intensive use.
- Powerful motor of 2.2 kW.
- 100% stainless steel for a perfect hygiene and unparalleled durability.
- Handy thanks to its wheels.
- Retractable and compact.
- Adjustable working height and foldable to allow minimum space for storage.

## ACCESSORIES

- Blender tool: Ref. TB004
- Whisk tool: Ref. TB003
- Dynapump : Ref. TB030 and Gun : Ref. TB040
- Potato tool masher : Ref. TB013



## USE

**Mixer:** Ideal to blend preparations (vegetable or fish soups...).

**Blender:** Mix, crush, grind, smooth into fine particles in a few minutes! This system provides a smooth, unctuous and airy texture.

**Dynapump:** With its innovative process, the DYNAMIC Pump perfectly adapts to the GIGAMIX blender foot to quickly and effortlessly transfer the mixed preparation into the packaging area.

**Whisk:** Ensures a perfect homogenization of preparations like instant mashed potatoes, dehydrated soups...

**Potato tool masher:** Especially designed for high volume preparations in central kitchens and collective catering. It allows to work from 50 to 150 kg of potatoes, carrots, celeriac, cauliflowers and broccolis all at one.

**Capacity: 100 to 300 L.**

VARIABLE SPEED COMPULSORY

## ACCESSORIES



**Dynapump**  
adaptable on  
Blender tool only

Ref. : **TB030**



**Gun**

Ref. : **TB040**

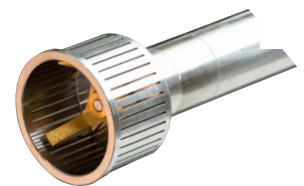

**Blender tool**

Ref. : **TB004**

**LIST PRICE \$3750**

**\$2660**

**\$5040**

PRICES DO NOT INCLUDE GST | 1 MARCH 2025 V2 AUD







# TURBO LIQUIDISERS SERIES

## GIGAMIX XS BLENDER

Ref : TB120 / Three-phased



COMPACT SIZE,  
IDEAL FOR HIGH  
VOLUME PREPARATIONS !



### DESCRIPTION

- Enhanced maneuverability thanks to its 3 wheels of which 1 steering wheel.
- Compact size, minimum space requirement. Easy storage thanks to its size.
- Retractable equipment.
- All stainless steel for easy cleaning and a perfect hygiene.
- Blocking system.
- Accessory storage box.
- Works directly in pots.
- Offers long service lifetime for intensive use.
- Long operating life.



BLOCKING SYSTEM

### ACCESSORIES

- DYNA PUMP : Ref. TB030
- GIGAMIX GUN : Ref. TB040



### USE

**Blender** : Grind, crush, mix, emulsify, homogenize and smooth your preparations in a record time !

The blender homogenizer tool allows to obtain a smooth, creamy and a perfect texture, that doesn't require sieving.

**Dynapompe** : With its innovative process, the DYNAMIC Pump perfectly adapts to the GIGAMIX blender foot to quickly and effortlessly transfer the mixed preparation into the packaging area.

**Capacity** : 40 to 150 L.

The GIGAMIX XS, GIGAMIX's "little sister" is designed for medium preparations.

This turbo liquidiser is specially designed for intensive use in production kitchens.



### TECHNICAL DATA

|                               |  |
|-------------------------------|--|
| OUTPUT                        | 1.5 KW                                 |
| SPEED                         | 2800 R.P.M.                            |
| VOLTAGE                       | 400 V three-phase with neutral, 50 Hz* |
| MINIMUM HEIGHT - under bell - | 190 mm                                 |
| MAXIMUM HEIGHT - under bell - | 850 mm                                 |
| DIAMETER BELL                 | 98 mm                                  |
| ACTUAL WEIGHT                 | 71 kg                                  |

\*Other voltages on request.

**LIST PRICE \$15300 TB120**



### Dynapump Gigamix

Adaptable on Blender tool only.

Tube's length provided with the pump : 2.5m

Ref. : **TB030**



### Gigamix Gun

Optional accessory for Dynapump.

Ref. : **TB040**

**No matter how efficiently you manage your supply chain and logistics, food service inevitably generates food waste that needs proper handling. Without effective processing, every kilogram of food waste produces six litres of harmful methane in a landfill.**

**FSM is here to help you find the right solution for your business. Let us assist you in navigating these changes and managing your food waste sustainably. Also available our food waste disposal units that can be connected to our remote dewaterers. Talk to the team today!**



## WASTE STATION

This standalone food waste processing station, or 'wastestation', benefits from Ecofast's unique macerating system and incorporates a host of sensors to ensure that it can't be operated and/or damaged through use either without water or with incorrect phasing. This reduces potentially costly errors during installation and operation. It uses nearly 30% less water than its nearest competitor and, with special filters, can be connected to recycled rainwater. The automatic cleaning system reduces labour time and odours but increases reliability.

**LIST PRICE POA**

| <b>1000 – SC1B Mark III Food Waste Dehydra</b>                                    | <b>(DxWxH)</b>  |
|---|---|
| D1000 Dewaterer Dimensions (mm)   | 700x1000x900  |
| "Water connections –<br>1 x Cold Water<br>1 x Hot water for cleaning system only" | 15mm standard hose connections<br>Hot water self cleaning cycle |
| Capacity (Food Waste) up to per minute / hour (kg)                                | 13 / 800  |
| Electrical Phase  | 3   |
| Motor voltage (v)   | 415   |
| Built in Cutlery Saver  | As standard   |



## FOOD WASTE DISPOSAL UNIT

The D390 unit incorporates a powerful 2.2kw braked motor with cast stainless-steel cutting rotor and grinder making it the most powerful compact macerating unit on the market. Although the unit can be used as a stand-alone unit it is designed to be used in conjunction with our dewatering systems. The design of the D390 enables it to be welded into tabling or a warewash system.

- 800kg capacity (food waste) per hour
- 3 Phase
- 415V
- Supplied with remote control panel
- Optional cutlery saver available

**D390 FOOD WASTE DISPOSAL UNIT with standard hopper (PICTURED)**

**D391 FOOD WASTE DISPOSAL UNIT for connection to single trough**

**D392 FOOD WASTE DISPOSAL UNIT for connection to double trough**

**LIST PRICE POA**



### MANUAL & ELECTRIC CAN OPENERS

Etlund are the industry leaders in quality, reliable can opening solutions and produce a wide range to suit any work load. Made tough with quality components, yet easy and safe to operate.

► Quality manufactured in USA ► Parts remove easily for replacement and cleaning ► Etlund blades are reversible for longer life ► Knife edges are intentionally dull and rounded to fold metal not cut it, thereby providing a smooth rim edge for greater safety.

#### MODEL 1

Nickel plated opener and sturdy base with standard length bar, suitable for cans up to 280mm tall.

4 cans per minute.

Recommended daily use up to 15 cans.

Overall Height: 530mm

Weight packed: 8.1Kgs

LIST PRICE EA. **\$490**

MEDIUM USAGE



### ELECTRIC CAN OPENERS

► Effortless electric operation to eliminate fatigue ► Spring-loaded mechanism opens even dented cans ► Replaceable knife and gear provide long life ► Sleek stainless steel construction provides durable operation and easy cleaning.

#### 266

Single Speed Electric Can Opener

4-7 cans per minute.

Recommended daily use up to 75 cans.

Most suitable for size #10 cans.

Dimensions: 111Wmm x 178Dmm x 305Hmm

Weight: 5.57Kgs

Electrical: 120W 0.5A Supplied with 10 amp plug.

LIST PRICE EA. **\$2930**

EFFORTLESS MEDIUM to HIGH USAGE



### CROWN PUNCH CAN OPENERS – PNEUMATIC

#### 610

Unit complete with knife and guard ring locator for one standard size #10 round can.

All stainless steel including mechanism.

8-12 cans per minute.

Recommended daily use up to 400 cans.

(Note: Compressor not included).

LIST PRICE EA. **\$18980**

HIGH PRODUCTION





## SANITATION & STORAGE

The patented KSUV-18 Knife Sterilizer Cabinet provides superior sterilization compared to other methods or products using magnetic bars or metal racks to secure the knives. The exclusive non-filtering clear slotted knife holder and special mirrored interior walls eliminate shadows on knife surfaces within the cabinet that could prevent complete sterilization. The easy to operate mechanical timer can be set for up to 15 minutes, but the KSUV-18 will safely sterilize your knives in as little as 3 minutes with 99% efficacy\*\*. It's like a SPF-99 (Sterilization Protection Factor) for your knives.



\*Note: Knives not included

- 15 minute belled timer
- Holds up to 12 knives plus steel\*
- Stainless steel construction
- LED lights indicate when door is closed and sterilization is in process
- UV filtered plexiglass door with lockable keyed handle
- Exclusive non UV filtering slotted knife holder
- 2 Larger slots to accommodate cleavers
- Safety interlock door

| CODE    | W X D X Hmm     | KG   | \$   |
|---------|-----------------|------|------|
| KSUV-18 | 483 x 150 x 610 | 13.7 | 4600 |

## CONTACT US FOR OTHER ITEMS AVAILABLE IN THE RANGE



Heavy Duty Crown Punch Can Openers

Can Crushers - Electric (pictured), air powered and manual available



From one of Italy's leading design and manufacturing facilities comes this remarkable quality range of equipment with excellent performance, leading edge style and design.



## ELEGANCE DROP-IN REFRIGERATED WELLS

Standard features include refrigerated cross-flow cold air wells with adjustable air flow velocity to suit even delicate foods, and height adjustable between 30 to 150mm deep.

Convenient lift-up evaporator for easy cleaning. Digital control system for adjusting temperature and automatic defrosting. Well Temperature +2°C to +5°C. Supplied with R290 gas and designed to work in up to 43°C ambient temperature



All Drop-in units can be fitted with optional gantries, in light or heat models with single or two-sided glass.

## FULLY INTEGRATED MODELS

| MODEL      | SIZE             | WELL SIZE                | No PANS | AMPS | WATTS | \$    |
|------------|------------------|--------------------------|---------|------|-------|-------|
| 8046500THC | 800mmL x 700mmD  | 650L x 510D x 30/150mmH  | 2GN1/1  | 2    | 500   | 8995  |
| 8046501THC | 1125mmL x 700mmD | 980L x 510D x 30/150mmH  | 3GN1/1  | 3    | 700   | 9775  |
| 8046502THC | 1455mmL x 700mmD | 1310L x 510D x 30/150mmH | 4GN1/1  | 4    | 900   | 10360 |
| 8046503THC | 1780mmL x 700mmD | 1630L x 510D x 30/150mmH | 5GN 1/1 | 5    | 1100  | 12480 |
| 8046580THC | 2105mmL x 700mmD | 1960L x 510D x 30/150mmH | 6GN 1/1 | 6    | 1300  | 17220 |
| 8046499    | Evaporator Tray  | To suit all models       |         |      |       | 435   |

### REMOTE MODELS AVAILABLE - Contact your representative

All the above supplied with 10amp plug. Units require a drain/tundish/heated evaporator tray.

## DROP-IN HEATED CERAMIC GLASS HOTPLATE

These Italian Hotplates are engineered to keep warm food at the correct temperature in trays, pans or earthenware dishes.

The Ceran hotplate is flush-mounted into the stainless steel top for durability and easier cleaning.

Maximum operating surface temperature of 120°C is adjustable and controlled via a digital controller. Careful design and placement of the silicon heating blanket gives even heat across the ceramic glass hot plate, with faster warm up and better economy.



All Drop-in units can be fitted with optional gantries, in light or heat models with single or two-sided glass.

| MODEL   | DIMENSIONS       | TOP                       | No PANS | AMPS | WATTS | \$   |
|---------|------------------|---------------------------|---------|------|-------|------|
| 8046400 | 800mmL x 700mmD  | 650Lx510D (single glass)  | 2GN 1/1 | 5    | 1200  | 3720 |
| 8046401 | 1125mmL x 700mmD | 960Lx510D (single glass)  | 3GN 1/1 | 8    | 1800  | 4400 |
| 8046402 | 1455mmL x 700mmD | 1300Lx510D (double glass) | 4GN 1/1 | 10   | 2400  | 4800 |
| 8046403 | 1780mmL x 700mmD | 1610Lx510D (double glass) | 5GN 1/1 | 12.5 | 3000  | 6400 |



## GBG GRANITIME GRANITA MACHINES

### Granitime

The simplicity you need in a small space

The compact machine. Perfect for any type of business where simplicity, durability and professional performance is the most important thing.



#### Speed Up Service

Fast freeze technology that cuts down preparation times. Ideal for fast turnover in slush sales.



#### Stainless Steel

Robust and elegant appearance guaranteeing many years of service.



#### Reduce Operation time

Clean the P&P tap in one piece. Easy bowl Sealing.



#### Various types of drinks

Slush drinks, cold drinks, sorbets, frozen cocktails and other refreshing drinks.

- 1 PRACTICAL AND COMPACT DESIGN
- 2 TEMPERATURE DISPLAY
- 3 ADJUSTABLE CONSISTENCY
- 4 STANDBY MODE TO SAVE ENERGY



refrigerant gas  
**R290**

| CODE        | W X D X Hmm     | KG | POWER REQUIREMENTS | WATTS | CAPACITY       | \$   |
|-------------|-----------------|----|--------------------|-------|----------------|------|
| GRANITIME 1 | 210 x 500 x 900 | 30 | 10amp              | 800   | 1 x 12ltr bowl | 3595 |
| GRANITIME 2 | 420 x 500 x 900 | 55 | 10amp              | 1000  | 2 x 12ltr bowl | 5295 |
| GRANITIME 3 | 620 x 500 x 900 | 70 | 10amp              | 1200  | 3 x 12ltr bowl | 7430 |



# V AIR

BY GBG



## V-AIR by GBG

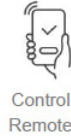
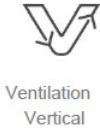

**15 L**  
LARGE Tank capacity

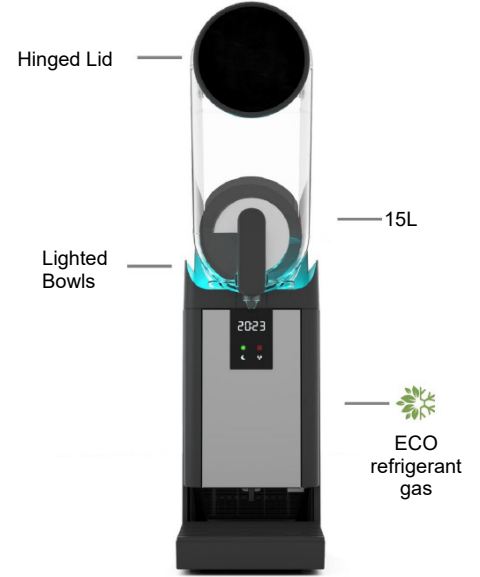

Just 215mm width

- Designed for better use of space
- Automatic modes
- Easy access filter
- Illuminated tanks (12 colours)
- Faucet with bayonet system
- Quick and easy cleaning

| CODE         | W X D X Hmm     | KG | POWER | WATTS | CAPACITY       | All units come with<br>Lid Flavour Tag<br>Remote Control with App<br>Full Lights | \$    |
|--------------|-----------------|----|-------|-------|----------------|--|-------|
| SMART PLUS 1 | 215 x 600 x 850 | 25 | 10amp | 350   | 1 x 15ltr bowl |  | 5995  |
| SMART PLUS 2 | 430 x 600 x 850 | 50 | 10amp | 700   | 2 x 15ltr bowl |  | 8995  |
| SMART PLUS 3 | 650 x 600 x 850 | 70 | 10amp | 1200  | 3 x 15ltr bowl |  | 11995 |

## V-DREAM

| Slush | Sherbet | Sorbet | Drinks | Frozen Cocktails | Milkshakes | Frapuccinos | Cream |
|-------|---------|--------|--------|------------------|------------|-------------|-------|
| ✓     | ✓       | ✓      | ✓      | ✓                | ✓          | ✓           | ✓     |

| MODEL   | W X D X Hmm     | KG | POWER | WATTS    | CAPACITY                 | \$    |
|---------|-----------------|----|-------|----------|--------------------------|-------|
| V-DREAM | 400 x 770 x 830 | 99 | 10amp | max 2000 | 18L Hopper & 7L Cylinder | 28950 |

- Refrigerated hopper
- Product ready in less than 20 minutes\*
- Direct drive cylinder mixer motor
- Brushless hopper mixer motor
- Modulated fan
- Multilanguage display
- Easy-to-remove filter





## DRINK MAGIC

### Refrigerated drink dispenser suitable for dairy products



#### Mix & Quality

Its continuous rotary system keeps the product well mixed and consistently blended for the best cold drink experience.



#### Push & Flow Tap

You can serve your drinks with only one hand, just press the glass against the tap to get the drink. It features high level of hygiene and simple to dismantle and clean.

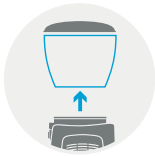

#### Enhanced Cleaning Process

Features an easy bowl release system that, without the need for any tools, decreases time spent during assembly and disassembly process.



#### Easy to Cold

Easy to use two-switch control panel. There is a mixer switch and cooling switch, simply flipping up these two switches starts the mixer motor and begins the cooling process.



#### Durable Design

Made of hard and resistant plastic, ensures long life cycle in your premises. The plastic parts won't rust like metal drink dispensers, keeping its professional appearance.



#### Right Temperature, Boost Flavour

For most people, right temperature can enhance flavours. It is equipped with a digital temperature control that allows to adjust the cooling temperature between 0°C - 10°C



#### Crystal Clear Bowls

The unit features durable, crystal clear poly-carbonate bowls. Maximise the visibility while minimizing the risk of breakage ensuring many years of use.



| MODEL              | DRINK MAGIC 20-1 |
|--------------------|------------------|
| BOWL CAPACITY      | 400 x 770 x 830  |
| NET WEIGHT         | 16.6KG           |
| POWER REQUIREMENTS | 10AMP            |
| WATTS              | 160              |
| TEMP CONTROL       | ADJUSTABLE       |
| CAPACITY           | 1 x 20ltr bowl   |
| LIST PRICE         | 2100             |





## WHITTY'S FLAVOURED SYRUPS

Premium ice frozen sugar base and natural fruit base flavoured syrups, for all GBG machines.

| PRODUCT        | DESCRIPTION                    | CODE   | FLAVOUR        | PREPERATION                                 | PACKAGING                      | RETAIL        |
|----------------|--------------------------------|--------|----------------|---|--------------------------------|---------------|
| Premium Slushy | Ice Frozen Sugar Base Beverage | WT-001 | Raspberry      | 1 litre of concentrate to 4 litres of water | Each carton:<br>3 x 2L Bottles | 48 per carton |
|                |                                | WT-002 | Blue Lemonade  |   |                                |               |
|                |                                | WT-003 | Cola           |   |                                |               |
|                |                                | WT-004 | Tropical Punch |   |                                |               |
|                |                                | WT-005 | Pine Lime      |   |                                |               |

| PRODUCT | DESCRIPTION   | CODE    | FLAVOUR   | PREPERATION                                 | PACKAGING                      | RETAIL         |
|---------|---|---------|-----------|---|--------------------------------|----------------|
| Slusha  | Fruit Base Beverage<br>All Natural Colours & Flavours<br>FOCIS approved | WTN-001 | Raspberry | 1 litre of concentrate to 4 litres of water | Each carton:<br>3 x 2L Bottles | 100 per carton |
|         |   | WTN-003 | Blueberry |   |                                |                |
|         |   | WTN-004 | Pine Lime |   |                                |                |
|         |   | WTN-006 | Fruitola  |   |                                |                |
|         |   | WTN-008 | Mango     |   |                                |                |







## GENERAL FOOD EQUIPMENT – MICROWAVE

**Designed for light to medium duty use in coffee shops, pizzerias, sandwich shops, self service areas, lunch break rooms, student lounges and more. Complete cooking and reheating of foods utilising up to 1000 watts of power with programmable 2 stage cooking.**

### GEW1050E

- 1000 Watts Cooking Power
- All Stainless steel exterior and interior
- 10 Power Levels
- Audible alarm when timed cycle is complete
- Large easy grip polished handle
- Reinforced flexible door latches to reduce breakage
- Electronic touch sensitive pad for programming, **2 stage cooking** and digital time display,
- Double or Triple quantity Function
- 28.3 Litres Internal Capacity
- 10 programs, ½ GN size
- 508W x 356D x 305Hmm External Dimensions
- 327W x 330D x 195Hmm Internal Dimensions
- 17Kg net/ 19Kg packed
- 6.3A (1500W). Supplied with 10A plug



**LIST PRICE EA.            \$680**



Since 1950, Hatco has been a leader in creating innovative ideas for the foodservice industry: bold innovations in equipment that improves efficiency, reliability and profits. Products are designed and built to handle the rugged demands of today's foodservice operations. Hatco is a company dedicated to exceptional customer service and quality engineered equipment offering maximum performance.

**TALK TO THE TEAM ABOUT THE COMPLETE RANGE AVAILABLE**

**Booster Water Heaters**

**Built-In Heated Shelves**

**Built-In Warmers**

**Carving Stations**

**Cold Shelves**

**Cold Wells**

**Decorative Lamps**

**Display Lights**

**Drawer Warmers**

**Frost Tops**

**Fry Stations**

**Heated Shelves**

**Heated Wells**

**Holding and Display**

**Cabinets**

**Hot/Cold Shelves**

**Ice Wells**

**Induction**

**Light Cooking Equipment**

**Merchandising Warmers**

**Nacho Chip Warmers**

**Pizza Warmers**

**Portable Warmers**

**Refrigerated Wells**

**Rethermalizers**

**Sanitizing Sink Heaters**

**Snack System**

**Soup Stations**

**Strip Heaters**

**Toasters**

**Innovative Solutions in  
Foodservice Equipment**



**Hatco, the world's leaders in food warming and holding technology, continue to lead the way with high quality, reliable and aesthetically correct Decorative Heat Lamps. With 21 shade styles, 24 colour and finish options, plus a choice of 4 mounting style and 3 switch options, there will be a model to suit your project or restaurant perfectly. Hatco Decorative Heat Lamps are perfect for enhancing your food pass/servery. Choose the lamps that the experts choose.**

**DECORATIVE HEAT LAMPS - IN STOCK - all others to order**

**DL-600-CL/BCOPPER**

Hatco Decorative Heat Lamp  
Features flexible cord mount to canopy.  
Overall length is 1829mm. (Longer length available on application).  
Black cord standard.  
Switch on lamp housing  
**Bright Copper plated finish.**  
Supplied unplugged

**LIST PRICE EA. \$1170**



**DL-400-CL/BOLD BLACK**

Hatco Decorative Lamp  
Features flexible cord mount to canopy.  
Overall length is 1829mm (Longer length available on application).  
Black cord standard.  
Switch on lamp housing.  
**Bold Black finish.**  
Supplied unplugged

**LIST PRICE EA. \$850**



**DL-500-RL-CH/BK**

Hatco **Retractable** Decorative Heat Lamp  
Features a cord which adjusts the lamp up and down from 787 mm to 1765 mm.  
Black cord is standard.  
Switch on lamp housing.  
**Glossy grey finish.**  
Supplied unplugged

**LIST PRICE EA. \$1390**



**DL-775-RPL-BN/BK**

Hatco **Retractable** Decorative Heat Lamp  
Features a cord which adjusts the lamp up and down from 787 mm to 1765 mm.  
Black cord is standard.  
Switch on lamp housing.  
**Bright Nickel finish.**  
Supplied unplugged

**LIST PRICE EA. \$1720**



**DL-500-CL-CH/BK**

Hatco Decorative Lamp  
Features flexible cord mount to canopy.  
Overall length is 1829mm (Longer length available on application).  
Black cord standard.  
Switch on lamp housing.  
**Glossy grey finish.**  
Supplied unplugged

**LIST PRICE EA. \$850**



**DL-750-RL/BOLD BLACK**

Hatco **Retractable** Decorative Heat Lamp  
Features a cord which adjusts the lamp up and down from 787 mm to 1765 mm.  
Black cord is standard.  
Switch on lamp housing.  
**Bold Black finish.**  
Supplied unplugged

**LIST PRICE EA. \$1465**



All lamps supplied with 250watt Food Grade Teflon-coated heat lamp to meet Australian Food Standard regulations. (Spare Part N02.30.100.00)

Recommended height is no more than 350mm from target surface from underside of lamp.





## NEW RETRACTABLE CORD MOUNT - DL-750-RCL/BOLD BLACK

### DL-750-RCL-BOLD BLACK

Features a cord which adjusts the lamp up and down from 610 mm to 1829 mm.

Black cord is standard.

Switch on lamp housing.

**Bold Black finish.**

Supplied unplugged

LIST PRICE EA.      **\$1995**

Smooth operation and improved reliability

Easier cleaning

AVAILABLE DECEMBER 2024



## NEW RETRACTABLE CORD MOUNT - SPECIAL ORDER OPTIONS

### 1 SELECT SHADE STYLE

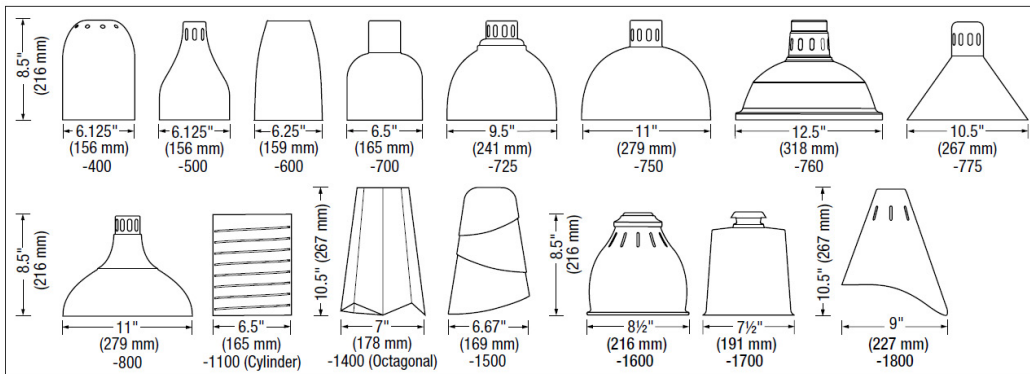

### 2 SELECT COLOUR/FINISH

#### DESIGNER COLORS

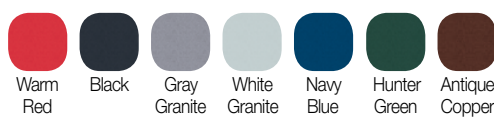

#### GLOSS FINISHES



#### PLATED FINISHES



Shade color/finishes available for DL-1500 only  
Select a different color or finish for the rest of the unit.

### 3 NEW MOUNTING TYPE

**RC Mount<sup>®</sup>**  
Retractable  
Cord Mount.

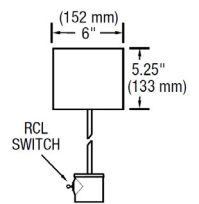

### 4 SELECT SWITCH LOCATION

**(N)-None**  
Supplied by installer

**(L)-Lower  
Switch**  
(Horizontal toggle)

Not available on:  
• DLH (High Watt models)  
• 2X00 shade styles





## HOW TO ORDER NON STOCK LAMPS - Contact us for a quote

### 1 SELECT SHADE STYLE

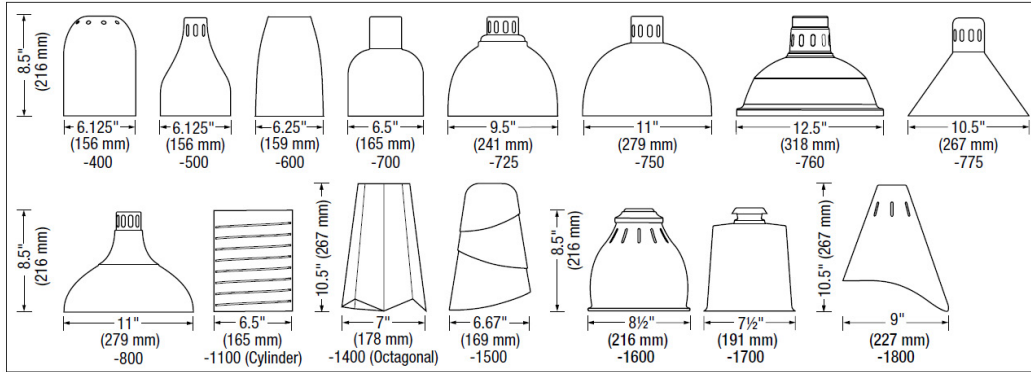

**NOTE:**  
DL-2100, -2200, 2300 or 2400  
Not available with:  
• Lower switch  
• R or RT Mounting  
• RC or RCT Mounting  
• C or CT Mounting

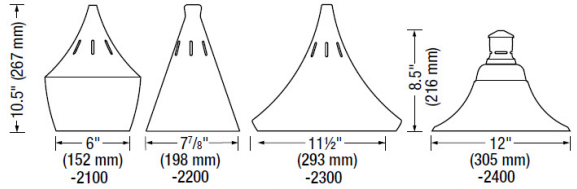

### 2 SELECT COLOUR/FINISH

Hatco is proud to introduce IFS antimicrobial powder coatings to the paint process for designer colours and gloss finishes - fighting germs to keep customers happy, healthy and safe.

IFS antimicrobial coatings use naturally-occurring, environmentally sustainable, silver ions to help inhibit the growth of microbes on the powder coated surface.

#### DESIGNER COLORS

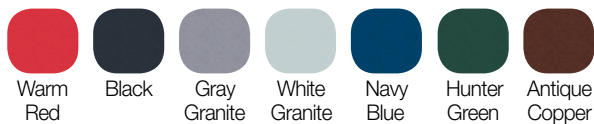

#### GLOSS FINISHES



Only available for shades. Select a different option for the rest of the unit.

#### PLATED FINISHES

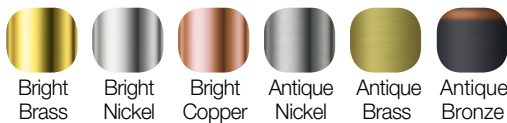

#### Shade color/finishes available for DL-1500 only

Select a different color or finish for the rest of the unit.



### 3 SELECT MOUNTING TYPE

**C Mount**<sup>®</sup>  
Cord Mount to canopy.

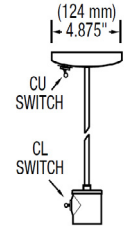

**R Mount**<sup>®</sup>  
Coiled Retractable Cord Mount.

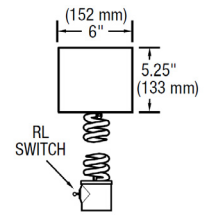

**RC Mount**<sup>®</sup>  
Retractable Cord Mount.

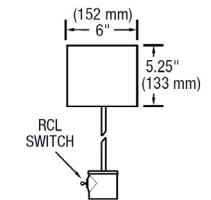

**S Mount**<sup>®</sup>  
Rigid Stem Mount to canopy.

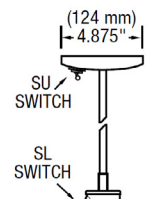

**AS Mount**<sup>®</sup>  
At install only, limited height adjustments with Rigid Stem Mount to canopy.

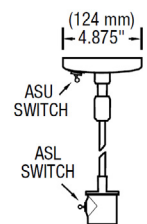

### 4 SELECT SWITCH LOCATION

**(N)-None**  
Supplied by installer

**(L)-Lower Switch**  
(Horizontal toggle)

Not available on:  
• DLH (High Watt models)  
• 2X00 shade styles

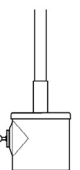

**(U)-Upper Switch**  
Not available on:  
• DLH (High Watt models)  
• R, RC Mounts  
• Track Mounts (CT, RT, RCT, ST, AST)

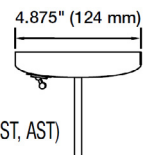



## GLO-MAX® GM5AH CURVED INFRARED STRIP HEATERS

This stylish, patented design, based on our signature Glo-Max® strip heaters, is the perfect solution for your front-of-the-house applications. Superb for buffet and serving lines, the sleek curved design minimizes its size while accenting and warming the products below. GM5AHL, with versatile LED lighting options, provides perfect coloring and coverage while lowering energy costs.

| CODE      | VOLTAGE   | WATTS       | AMPS | DIMENSIONS           | WEIGHT | \$   |
|-----------|-----------|-------------|------|----------------------|--------|------|
| GM5AH-30  | 230 ~ 240 | 606 ~ 660   | 2.8  | 762W x 150D x 50Hmm  | 5Kg    | 750  |
| GM5AHL-30 | 230 ~ 240 | 606 ~ 660   | 2.8  |                      | 6Kg    | 1190 |
| GM5AH-36  | 230 ~ 240 | 735 ~ 800   | 3.3  | 915W x 150D x 50Hmm  | 6Kg    | 800  |
| GM5AHL-36 | 230 ~ 240 | 756 ~ 812   | 3.4  |                      | 6Kg    | 1295 |
| GM5AH-42  | 230 ~ 240 | 872 ~ 950   | 4.0  | 1067W x 150D x 50Hmm | 7Kg    | 835  |
| GM5AHL-42 | 230 ~ 240 | 885 ~ 964   | 4.0  |                      | 7Kg    | 1410 |
| GM5AH-48  | 230 ~ 240 | 1010~1100   | 4.6  | 1220W x 150D x 50Hmm | 7Kg    | 890  |
| GM5AHL-48 | 230 ~ 240 | 1025~1116   | 4.7  |                      | 8Kg    | 1540 |
| GM5AH-54  | 230 ~ 240 | 1148 ~ 1250 | 5.2  | 1372W x 150D x 50Hmm | 8Kg    | 935  |
| GM5AHL-54 | 230 ~ 240 | 1163 ~ 1267 | 5.3  |                      | 8Kg    | 1770 |
| GM5AH-66  | 230 ~ 240 | 1433 ~ 1560 | 6.5  | 1675W x 150D x 50Hmm | 9Kg    | 1095 |
| GM5AHL-66 | 230 ~ 240 | 1450 ~ 1579 | 6.6  |                      | 10Kg   | 1745 |
| GM5AH-78  | 230 ~ 240 | 1736 ~ 1890 | 7.9  | 1981W x 150D x 50Hmm | 10Kg   | 1270 |
| GM5AHL-78 | 230 ~ 240 | 1754 ~ 1910 | 8.0  |                      | 11Kg   | 2340 |



Shown on optional stand (NTL5-16)

Clear anodized is the standard housing color

Angle brackets are standard, non-adjustable tubular stands, 406 mm (16"), are an optional extra

Warm LED light (3000K)

Power wire lead length is 1524 mm

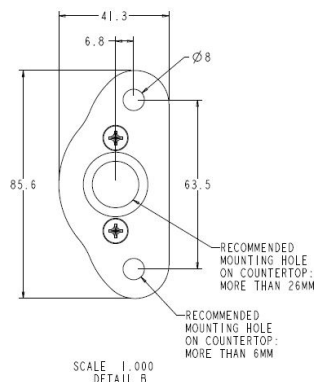
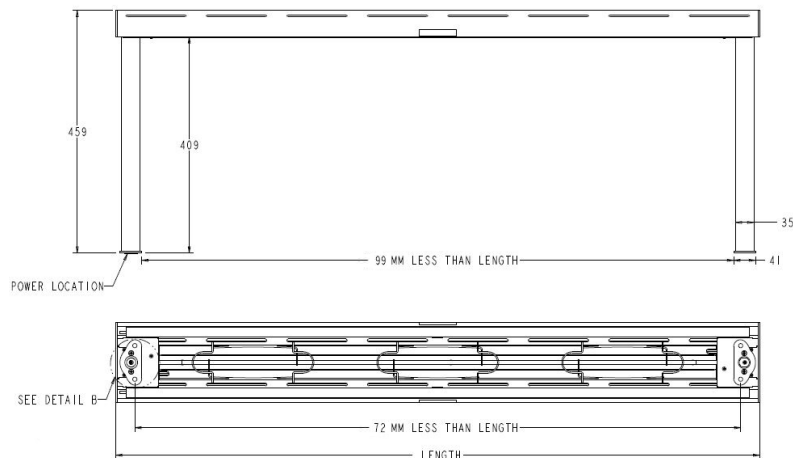
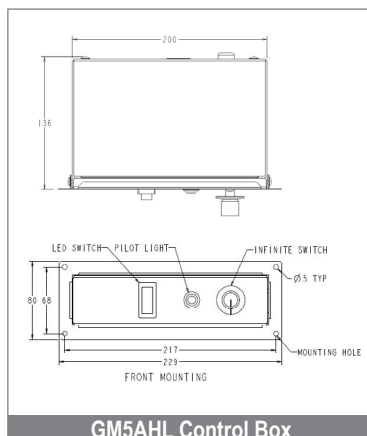
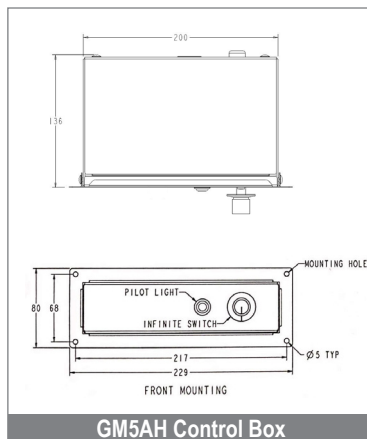





## GLO-MAX® HLC5 LED CURVED DISPLAY LIGHTS

A stylish choice for illuminating your serving area. The HLC5 LED Display Light offers the highest light output that is ideal for illuminating food products with a cool white light (4000K). The sleek, curved design is patented and the LED lighting delivers significant savings with lower energy consumption and greater reliability.

| CODE    | VOLTAGE   | WATTS | AMPS     | WEIGHT | DIMENSIONS         | \$   |
|---------|-----------|-------|----------|--------|--------------------|------|
| HLC5-30 | 220 ~ 240 | 11    | 0.05     | 4kg    | 762 x 150 x 50 mm  | 880  |
| HLC5-36 | 220 ~ 240 | 14    | 0.06     | 4kg    | 915 x 150 x 50 mm  | 950  |
| HLC5-42 | 220 ~ 240 | 15~16 | 0.07     | 5kg    | 1067 x 150 x 50 mm | 980  |
| HLC5-48 | 220 ~ 240 | 17    | 0.08     | 6kg    | 1220 x 150 x 50 mm | 1005 |
| HLC5-54 | 220 ~ 240 | 19    | 0.08     | 7kg    | 1372 x 150 x 50 mm | 1085 |
| HLC5-66 | 220 ~ 240 | 22    | 0.09~0.1 | 8kg    | 1675 x 150 x 50 mm | 1185 |
| HLC5-78 | 220 ~ 240 | 24    | 0.1~0.11 | 8kg    | 1981 x 150 x 50 mm | 1350 |

Clear anodized is the standard housing color  
 Angle brackets are standard, non-adjustable tubular stands, 406 mm (16"), are an optional extra  
 Rocket Switch, location: under unit on power side  
 Power wire lead length: 1524mm



Shown on optional stand.

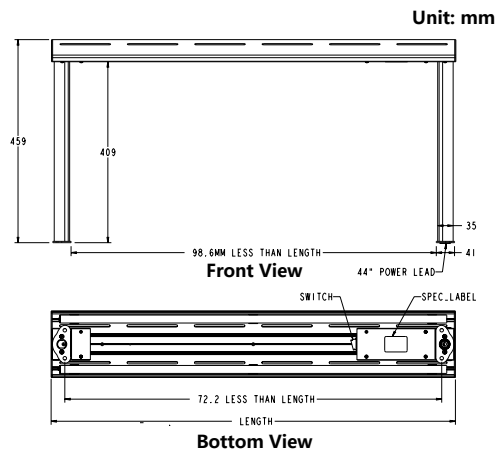
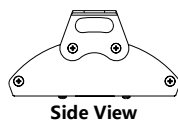
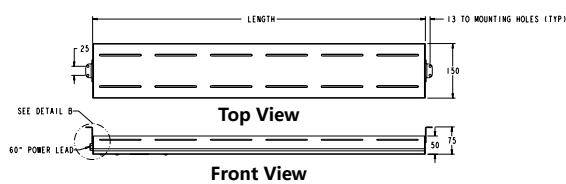



Acknowledged world leaders in food holding and warming solutions, Hatco offer a breadth of products and solutions that answer almost any heating/warming/holding requirement.

And Hatco lead the way in merchandising solutions with high quality - high visibility products. Call to discuss your special requirements or project needs - Hatco has a quality solution and Hatco products are covered by our exclusive 13 month warranty on parts and labour.

## GLO RAY FOOD WARMER GRAH Heat only

Sturdy cast aluminium housing with patented metal sheathed heating rods and designed heat deflectors to control heat pattern (See schematic below). Safety wire guards, hanging tabs and 1800mm cord with 10A plug standard. **All units 150mmW x 64mmH**

| MODEL   | \$   | LENGTH | WATTAGE | MODEL-IC   | LENGTH                    | \$   |
|---------|------|--------|---------|------------|---------------------------|------|
| GRAH-18 | 685  | 460mm  | 350W    | GRAH-18-IC | 460mm                     | 860  |
| GRAH-24 | 715  | 610mm  | 500W    | GRAH-24-IC | 610mm                     | 890  |
| GRAH-30 | 756  | 760mm  | 660W    | GRAH-30-IC | 760mm                     | 930  |
| GRAH-36 | 795  | 910mm  | 800W    | GRAH-36-IC | 910mm                     | 970  |
| GRAH-42 | 845  | 1070mm | 950W    | GRAH-42-IC | 1070mm                    | 1020 |
| GRAH-48 | 890  | 1220mm | 1100W   | GRAH-48-IC | 1220mm                    | 1060 |
| GRAH-54 | 940  | 1370mm | 1250W   | GRAH-54-IC | 1370mm                    | 1115 |
| GRAH-60 | 995  | 1520mm | 1400W   | GRAH-60-IC | 1520mm                    | 1170 |
| GRAH-66 | 1080 | 1680mm | 1560W   | GRAH-66-IC | 1680mm                    | 1255 |
| GRAH-72 | 1210 | 1830mm | 1725W   | GRAH-72-IC | 1830mm                    | 1385 |
| GRAH-84 | 1390 | 2130mm | 1900W   | GRAH-84-IC | 2130mm                    | 1450 |
| GRAH-96 | 1570 | 2440mm | 2400W   | GRAH-96-IC | 2440mm </td <td>1740</td> | 1740 |



FOR INFINITE CONTROL MODELS SEE "IC" COLUMN ←

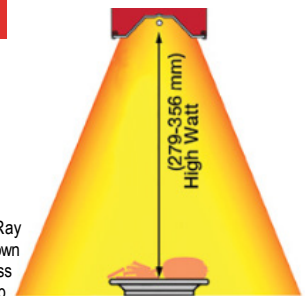

Typical Glo Ray installation shown above stainless steel benchtop.

## GLO RAY FOOD WARMER GRAHL Heat & Light

Sturdy cast aluminium housing with patented metal sheathed heating rods and designed heat deflectors to control heat pattern. Includes Incandescent lighting, safety wire guards, hanging tabs and 1800mm cord with 10A or 15A\* plug standard. **All units 230mmW x 64mmH**

| MODEL    | \$   | LENGTH | WATTAGE    | MODEL-IC    | LENGTH | \$   |
|----------|------|--------|------------|-------------|--------|------|
| GRAHL-18 | 935  | 460mm  | 470W       | GRAHL-18-IC | 460mm  | 1110 |
| GRAHL-24 | 970  | 610mm  | 620W       | GRAHL-24-IC | 610mm  | 1140 |
| GRAHL-30 | 1080 | 760mm  | 780W       | GRAHL-30-IC | 760mm  | 1260 |
| GRAHL-36 | 1215 | 910mm  | 980W       | GRAHL-36-IC | 910mm  | 1390 |
| GRAHL-42 | 1290 | 1070mm | 1130W      | GRAHL-42-IC | 1070mm | 1460 |
| GRAHL-48 | 1440 | 1220mm | 1340W      | GRAHL-48-IC | 1220mm | 1610 |
| GRAHL-54 | 1540 | 1370mm | 1490W      | GRAHL-54-IC | 1370mm | 1720 |
| GRAHL-60 | 1720 | 1520mm | 1700W      | GRAHL-60-IC | 1520mm | 1890 |
| GRAHL-66 | 1850 | 1680mm | 1860W      | GRAHL-66-IC | 1680mm | 2020 |
| GRAHL-72 | 2100 | 1830mm | 2085W      | GRAHL-72-IC | 1830mm | 2270 |
| GRAHL-84 | 2465 | 2130mm | 2470W* 15A | GRAHL-84-IC | 2130mm | 2640 |
| GRAHL-96 | 2700 | 2440mm | 2880W* 15A | GRAHL-96-IC | 2440mm | 2880 |

FOR INFINITE CONTROL MODELS SEE "IC" COLUMN ←

## REMOTE CONTROLS & IC UNITS

Use 1 Infinite Control per Glo Ray element

| MODEL   | DESCRIPTION                                       | \$  |
|---------|---|-----|
| RMB-3CE | Remote Control Enclosure with 1 Infinite Control  | 390 |
| RMB-7CE | Remote Control Enclosure with 2 Infinite Controls | 540 |



RMB-3CE



Dual Remote Control RMB-7CE

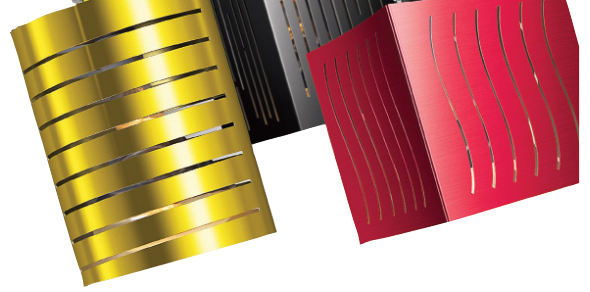

Hatco heated shelves are the benchmark for quality, reliability and style when it comes to holding food at serving temperatures.

Choose from portable table-top models, drop-in or flush mount models to suit any project or venue requirement, and serve with style and practicality.

## HEATED BLACK GLASS PORTABLE SHELVES 400mm DEEP

### HGSM-4060

Hatco's Heated Glass Shelf Modular units feature black ceramic glass to create uniform heat across the entire surface to hold hot food at safe-serving temperatures for longer without affecting product quality. Modular design allows for multiple units to be placed side-by-side and for easy cleaning and maintenance.

Includes thermostatic controls with five temperature settings of 55°C, 65°C, 75°C, 85°C and 95°C. Touch Panel Control.

Constructed with a durable stainless steel housing.

Weight: 7.5Kgs Dimensions: 400W X 600D X 56Hmm

Electrical: 300 Watts, 1.3 amp. supplied with corded 10amp plug.

LIST PRICE EA. **\$1280**

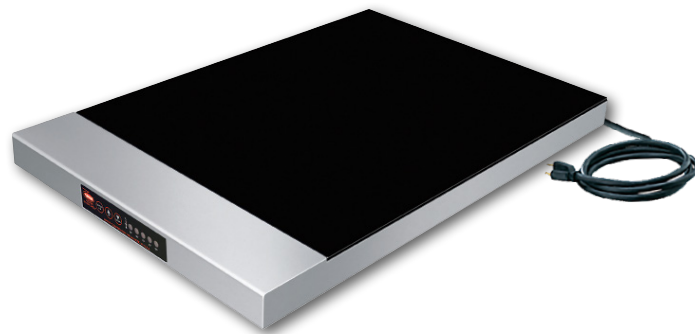

## GLO-RAY® GRS PORTABLE HEATED SHELF 495mm DEEP

Convenient portable heated shelf units 495mm 'deep', that offer the flexibility of use when and where needed. Hatco's unique blanket element design provides even temperature across the shelf for extended product serving/holding times.

Temperature Range: 27-82°C. Designer colours to order.

| CODE     | DIMENSIONS                 | WATTS | WEIGHT | \$   |
|----------|----------------------------|-------|--------|------|
| GRS-24-I | 610 mm long x 495 mm deep  | 380   | 10Kg   | 1920 |
| GRS-30-I | 762 mm long x 495 mm deep  | 490   | 12Kg   | 2060 |
| GRS-36-I | 914 mm long x 495 mm deep  | 598   | 13Kg   | 2210 |
| GRS-42-I | 1067 mm long x 495 mm deep | 652   | 15Kg   | 2480 |
| GRS-48-I | 1219 mm long x 495 mm deep | 760   | 17Kg   | 2590 |
| GRS-54-I | 1372 mm long x 495 mm deep | 870   | 20Kg   | 2780 |

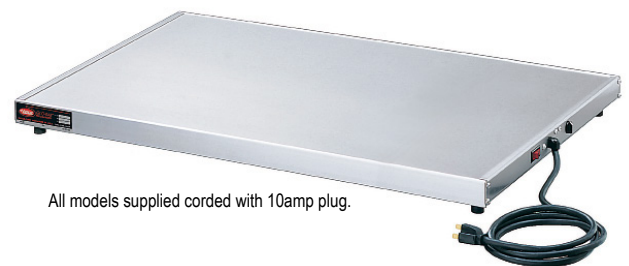

All models supplied corded with 10amp plug.



Shown with optional pan guards.

## GLO-RAY® GRS PORTABLE HEATED SHELF 305mm DEEP

Convenient portable heated shelf units 305mm 'deep' models, perfect for burger or product make-up and holding on the one bench space. Hatco's unique blanket element design provides even temperature across the shelf for extended product serving/holding times. Designer colours to order.

| CODE     | DIMENSIONS                 | WATTS | WEIGHT | \$   |
|----------|----------------------------|-------|--------|------|
| GRS-60-D | 1524 mm long x 305 mm wide | 600   | 16Kg   | 2300 |
| GRS-72-D | 1829 mm long x 305 mm wide | 700   | 17Kg   | 2390 |



All the above supplied corded with 10amp plug.



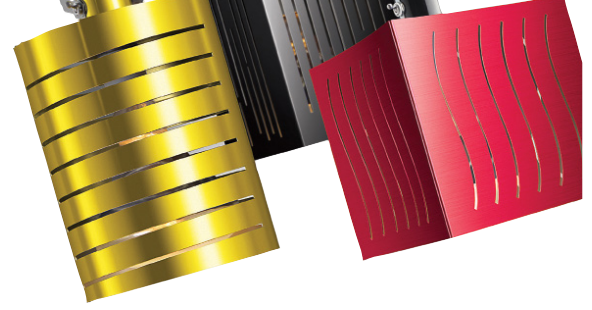

## GLO-RAY® GRSBF DROP-IN FLUSH TOP HEATED SHELF

Satin Black hard coated aluminium finish with flush mount, for a smooth professional finish, includes remote temperature control and ON/OFF switch.

Ideal for use on pass-through areas, buffet lines and as hors d'oeuvre displays. They feature a thermostatically-controlled blanket-type foil element heated surface to help hold your food hot and delicious with consistent temperatures across the shelf. Adjustable thermostat controls allow surface temperature for the GRSBF to range from 27° to 82°C.

| CODE       | DIMENSIONS (all 60mm height) | WATTS | WEIGHT | \$   |
|------------|------------------------------|-------|--------|------|
| GRSBF-24-I | 648mm long x 533 mm wide     | 550   | 13Kg   | 3380 |
| GRSBF-30-I | 800 mm long x 533 mm wide    | 665   | 14Kg   | 3570 |
| GRSBF-36-I | 953 mm long x 533 mm wide    | 780   | 14Kg   | 3830 |
| GRSBF-42-I | 1105 mm long x 533 mm wide   | 885   | 15Kg   | 4015 |
| GRSBF-48-I | 1257 mm long x 533 mm wide   | 1000  | 18Kg   | 4225 |
| GRSBF-54-I | 1372 mm long x 533 mm wide   | 1220  | 22Kg   | 4450 |
| GRSBF-60-I | 1562 mm long x 533 mm wide   | 1220  | 22Kg   | 4690 |
| GRSBF-72-I | 1867 mm long x 533 mm wide   | 1440  | 24Kg   | 4990 |



All the above supplied corded with 10amp plug.

Please note: depths/widths other than 533mm available on request: 432, 648, 800mm.

## GLO-RAY® HBGB DROP-IN HEATED BLACK CERAMIC GLASS SHELF

For a dramatic and professional food serving area, the Hatco Heated Black Glass Shelf has a heated ceramic glass surface to create uniform heat across the entire surface and display food perfectly.

Ideal for use on pass-through areas, buffet lines and as hors d'oeuvre displays. Surface colour is black ceramic glass and they feature a thermostatically-controlled heated ceramic glass surface to help hold your food hot and delicious. Food can be placed directly on the glass surface. Supplied with an attached stainless steel trim mounting ring for drop in installations.

Adjustable thermostat controls allow surface temperature for the HBGB to range from 38° to 90°C. Recommended for installation in metallic surfaces.

| CODE      | DIMENSIONS* (all 55mm Height) | WATTS | WEIGHT | \$   |
|-----------|-------------------------------|-------|--------|------|
| HBGB-2418 | 651 mm long x 498 mm wide     | 425   | 15Kg   | 5230 |
| HBGB-3018 | 803 mm long x 498 mm wide     | 525   | 17Kg   | 5460 |
| HBGB-3618 | 955 mm long x 498 mm wide     | 630   | 19Kg   | 5670 |
| HBGB-4818 | 1260 mm long x 498 mm wide    | 850   | 23Kg   | 6230 |
| HBGB-6018 | 1565 mm long x mm 498 wide    | 1050  | 29Kg   | 6650 |
| HBGB-7218 | 1870 mm long x 498 mm wide    | 1260  | 34Kg   | 7120 |



\* Outer dimensions of the stainless steel trim. All the above supplied corded with 10amp plug. **Controller dimensions 178 x 76mm.** Note: HBGB Units over 955 mm are constructed of two equal size pieces of glass. Recommended for use in a metallic countertop. For other surfaces, verify that the material is suitable for temperatures up to 94°C.



White ceramic glass available to order



## HATCO HOT OR GOLD SHELF

Serve hot buffet or cool salads/sweets on the same shelf space easily and quickly with flexibility to suit your venue. These units come in traditional Hardcoat finish or Swanstone® Simulated Stone Finish to match any decor, available as a Drop-In Flush mount. Save space and maximise the space you already have.

From the world-wide leaders in food holding solutions this versatile shelf satisfies your differing serving needs at the touch of a button. Patent-pending thermal break technology and renowned Hatco reliability - Hot OR Cold and now available Cold Only.

- Easily change between Hot or Cold in under an hour (approx) to suit your needs
- **Temperature Range:** -12°C to 82°C
- Control Box can be remotely mounted up to 1229mm from centre of the shelf
- Maximise the usage of your available space for hot or cold servings
- Durable Hardcoat Aluminium Finish Drop-In Flush Mount or Swanstone® food safe simulated stone colours available to match your decor and other Hatco Heated Shelves
- Famous Hatco performance and reliability
- Patent-pending thermal break reduces condensation and temperature transfer.
- Includes a remote-mountable control enclosure, with a three position power switch and two digital temperature controllers.

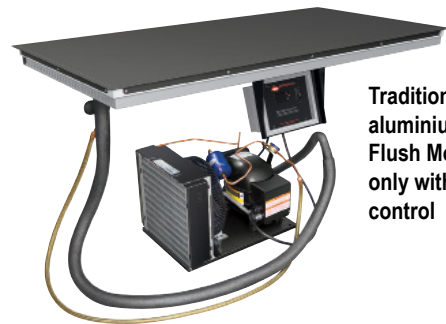

Traditional hard coat aluminium drop-in Flush Mount Cold only with remote control



Swanstone® Granite Gray simulated stone drop-in Flush Mount Hot or Cold with remote control



Hot or Cold Remote control with three position switch and two electronic temperature controls

### Stone Colours

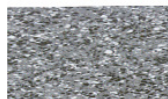

Gray Granite



Bermuda Sand

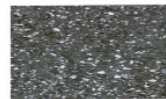

Night Sky

\*Swanstone Colour must be specified at time of order.

## Available as a Cold Only shelf.

Hatco's CSBF Cold Shelf Built-In Flush Top is a foodsafe shelf that is designed to keep pre-chilled food products in the perfect chill zone for serving. Features patent-pending thermal break that reduces condensation. Includes a power On/Off switch and digital temperature controller. Has a hardcoat aluminum surface and is designed to be top mounted.

| CODE        | DESCRIPTION                           | DIMENSIONS: (heated-cooled/overall) | Watts / Amps | Compressor | Weight | \$    |
|-------------|---------------------------------------|-------------------------------------|--------------|------------|--------|-------|
| HCSBF-24-I  | Drop-In Hot / Cold Shelf - Hardcoat   | 610W x 495mmD / 648W x 533mmD       | 804 / 3.5    | 1/4HP      | 58Kg   | 16350 |
| HCSBF-36-I  | Drop-In Hot / Cold Shelf - Hardcoat   | 914W x 495mmD / 953W x 533mmD       | 1044 / 4.5   | 1/3HP      | 68Kg   | 16790 |
| HCSBF-48-I  | Drop-In Hot / Cold Shelf - Hardcoat   | 1219W x 495mmD / 1257W x 533mmD     | 1044 / 4.5   | 1/3HP      | 84Kg   | 18700 |
| HCSSBF-24-I | Drop-In Hot / Cold Shelf - Swanstone* | 610W x 495mmD                       | 804 / 3.5    | 1/4HP      | 67Kg   | 16790 |
| HCSSBF-36-I | Drop-In Hot / Cold Shelf - Swanstone* | 914W x 495mmD                       | 1044 / 4.5   | 1/3HP      | 76Kg   | 17325 |
| HCSSBF-48-I | Drop-In Hot / Cold Shelf - Swanstone* | 1219W x 495mmD                      | 1044 / 4.5   | 1/3HP      | 92Kg   | 19060 |
| CSBF-24-I   | Drop-In Cold Shelf - Hardcoat         | 610W x 495mmD / 648W x 533mmD       | 816/3.5      | 1/3HP      | 53KG   | 14100 |
| CSBF-36-I   | Drop-In Cold Shelf - Hardcoat         | 914W x 495mmD / 953W x 533mmD       | 816/3.5      | 1/3HP      | 62Kg   | 14360 |
| CSBF-48-I   | Drop-In Cold Shelf - Hardcoat         | 1219W x 495mmD / 1257W x 533mmD     | 816/3.5      | 1/3HP      | 71Kg   | 16080 |



## HATCO® DROP-IN SLIM FROST TOP

Convenience meets style with the Hatco Drop-In Slim Frost Tops. Perfect for quick turn products on self-serve buffets. Save space and maximise the space you already have.

Hatco Drop-in Slim Frost Tops keep pre-chilled beverages, snacks, hors d'oeuvres and side dishes cool and ready to serve. Slim configuration provides wider access to your customers.

- Available in 2- and 3-pan slim configurations
- NSF 7 approved cold wall construction utilizes a refrigerant that keeps food product cold without drying it out
- Auto-defrost is activated through an advanced programmable electronic controller
- Matches the Hatco line of Heated Wells for an integrated look
- The condensing unit, mounted on the centre of the unit, rotates 180° (movable in some models)
- Long, flexible refrigerant line (ability to pull out condensing unit) for service
- Famous Hatco performance and reliability



FTB-S2 Drop-In Slim Frost Top

| CODE   | DESCRIPTION            | DIMENSIONS: (heated-cooled/overall) | Watts / Amps | Compressor | Weight | \$    |
|--------|------------------------|-------------------------------------|--------------|------------|--------|-------|
| FTB-S2 | Drop-In Slim Frost-Top | 1395W x 535D x 437Hmm               | 804 / 6.7    | 1/4HP      | 83Kg   | 16640 |
| FTB-S3 | Drop-In Slim Frost-Top | 2053W x 535D x 437Hmm               | 804 / 6.7    | 1/4HP      | 108Kg  | 17480 |

## HATCO® GOLD UNDERMOUNT SHELF

Hatco's CSU Cold Undermount Shelf is a foodsafe shelf that is designed to keep pre-chilled food products in the perfect chill zone for serving.

- Undermount shelves have the amazing benefit of being able to be installed under the counter top of your choice\*\*\*
- Long, flexible refrigerant line (ability to pull out condensing unit) for service
- Electronic Temperature Control Box with a 1219 mm lead wire
- Anodized aluminum surface

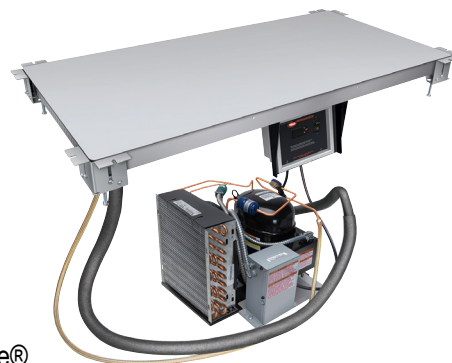

\*\*\*Approved materials include granite and quartz up to 30 mm, Swanstone® (provided by Hatco), and certain stainless steel or aluminum surfaces approved by Hatco. Please contact FSM for applications with other material

| CODE     | DESCRIPTION           | DIMENSIONS:           | Watts / Amps | Compressor | Weight | \$    |
|----------|-----------------------|-----------------------|--------------|------------|--------|-------|
| CSU-24-I | Cold Undermount Shelf | 697W x 579D x 257Hmm  | 1296 / 5.4   | 1/3HP      | 52Kg   | 14100 |
| CSU-36-I | Cold Undermount Shelf | 998W x 579D x 257Hmm  | 984 / 4.1    | 3/8HP      | 64Kg   | 14280 |
| CSU-48-I | Cold Undermount Shelf | 1303W x 579D x 257Hmm | 984 / 4.1    | 3/8HP      | 70kg   | 15550 |





## GLO-RAY® HEATED DISPLAY WARMERS

Boost impulse sales by showcasing your hot foods in the Hatco Glo-Ray merchandising warmers. Designed specifically for displaying wrapped or boxed product, these warmers hold hot food safely at proper serving temperatures and are seen in many of the best known venues around the world.

- ▶ Pre-focused infrared top heat directs heat to the outer edges where heat loss is greatest
- ▶ Convenient for self-serve or quick-serve areas
- ▶ Available in two-tier models with horizontal or slanted shelves
- ▶ Adjustable product divider rods sort food displays for convenience and product appeal
- ▶ Thermostatically controlled hard-coated heated base extends holding times
- ▶ Food grade Teflon coated incandescent lights illuminate the holding areas and product for maximum visibility.

### GRSDS *Slant* Model - all 617 mm deep

| CODE       | DESCRIPTION           | KW     | AMP      | WEIGHT | \$    |
|------------|-----------------------|--------|----------|--------|-------|
| GRSDS-24D  | Dual Shelf - 610 mmW  | 1.34kw | 5.6 amp  | 52Kg   | 11730 |
| GRSDS-30D  | Dual Shelf - 760 mmW  | 1.53kw | 6.4 amp  | 64Kg   | 12480 |
| GRSDS-36D  | Dual Shelf - 910 mmW  | 1.81kw | 7.6 amp  | 73Kg   | 13220 |
| GRSDS-41D  | Dual Shelf - 1040 mmW | 2.12kw | 8.8 amp  | 82Kg   | 14190 |
| GRSDS-52D* | Dual Shelf - 1320 mmW | 2.73kw | 11.4 amp | 98Kg   | 16480 |
| GRSDS-60D* | Dual Shelf - 1520 mmW | 3.34kw | 14 amp   | 108Kg  | 17400 |

Units 24D - 41D supplied corded with 10A plug.  
\*Units 52D - 60D supplied corded with 15A plug.



### GR2SDS *Slant* Model DESIGNER SERIES - All 677 mm deep

| CODE        | DESCRIPTION           | KW     | AMP      | WEIGHT | \$    |
|-------------|-----------------------|--------|----------|--------|-------|
| GR2SDS-24D  | Dual Shelf - 770 mmW  | 1.64kw | 6.9 amp  | 73Kg   | 13900 |
| GR2SDS-30D  | Dual Shelf - 920 mmW  | 2.04kw | 8.5 amp  | 84Kg   | 14850 |
| GR2SDS-36D* | Dual Shelf - 1070 mmW | 2.44kw | 10.2 amp | 91Kg   | 15840 |
| GR2SDS-42D* | Dual Shelf - 1220 mmW | 2.98kw | 12.5 amp | 99Kg   | 17260 |
| GR2SDS-48D* | Dual Shelf - 1380 mmW | 3.38kw | 14.1 amp | 116Kg  | 18680 |
| GR2SDS-54D^ | Dual Shelf - 1530 mmW | 3.78kw | 15.8 amp | 120Kg  | 20160 |
| GR2SDS-60D^ | Dual Shelf - 1680 mmW | 4.42kw | 18.4 amp | 135Kg  | 21500 |

Units 24D - 30D supplied corded with 10A plug.  
\*Units 36D - 48D supplied corded with 15A plug. ^Units 54D - 60D supplied unplugged.

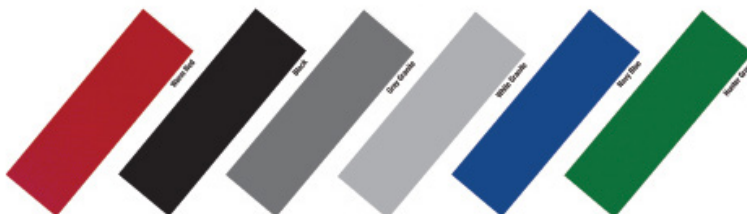

Horizontal models also available to order. Please specify colour at time of ordering, otherwise colour inserts and cap ends will be supplied in black.



## GLO-RAY® 2-GO HEATED SHELVES

Hatco's GRS2G Glo-Ray 2-Go™ Heated Shelf, designed specifically with delivery and carry-out needs in mind, is capable of holding a great quantity of hot food items at optimum serving temperatures.

- Holds bags and boxes of food for up to 30 minutes with a high temperature range up to 93°C.
- Touchscreen control with digital readout indicates separate heat and timer for each shelf.
- Features shelves with heated bases that are thermostatically-controlled and has a stainless steel frame.
- The cord is recessed into the bottom shelf at a 45° angle, allowing the unit to be flush against the wall.
- Includes 10amp plug



GRS2G-3920-4 shown

| CODE         | DESCRIPTION      | DIMENSIONS:            | Watts / Amps | Weight | \$   |
|--------------|------------------|------------------------|--------------|--------|------|
| GRS2G-3920-2 | 2 Heated shelves | 1093W x 508D x 546Hmm  | 766 / 3.2    | 69Kg   | 6595 |
| GRS2G-3920-3 | 3 Heated shelves | 1093W x 508D x 908Hmm  | 1148 / 4.8   | 80Kg   | 8310 |
| GRS2G-3920-4 | 4 Heated shelves | 1093W x 508D x 1270Hmm | 1529 / 6.4   | 91kg   | 9885 |

Optional side and back panels are one panel per shelf, giving you the flexibility to customize your unit.

| CODE            | DESCRIPTION  | \$        |
|-----------------|--|-----------|
| CONTROL-GRS2G-R | Controls and permanent panel on ride side in leaiu of standard left side   | No charge |
| S PANEL GRS2G S | Side Panel for GRS2G-3920<br>One panel per open shelf<br>-2 shelves require 1 side panel<br>-3 shelves require 2 side panels<br>-4 shelves require 3 side panels | 60        |
| B PANEL GRS2G S | Back Panel for GRS2G-3920<br>One panel per open shelf<br>-2 shelves require 1 back panel<br>-3 shelves require 2 back panels<br>-4 shelves require 3 back panels | 120       |



GRS2G-3920-3 with optional side panel (SPANEL-GRS2G3)



**GLO-RAY® 2-GO HEATED SHELVES - C MODELS**

- Holds bags and boxes of food for up to 30 minutes with a high temperature range up to 93°C.
- Shelves are 507 mm deep and 986 mm wide, with a 289 mm clearance between shelves that is large enough to fit a variety of carry out/delivery bags and boxes.
- Each shelf features a digital temperature control, a power On/Off switch, and jumper power cords.
- Units feature stainless steel shelves with heated bases that are thermostatically-controlled.
- Supplied flat packed
- Includes 10amp plug



GRS2GC-3920-4 shown

| CODE          | DESCRIPTION      | DIMENSIONS:           | Watts / Amps | Weight | \$   |
|---------------|------------------|-----------------------|--------------|--------|------|
| GRS2GC-3920-2 | 2 Heated shelves | 986W x 507D x 475Hmm  | 824 / 3.4    | 21Kg   | 3250 |
| GRS2GC-3920-4 | 4 Heated shelves | 986W x 507D x 1135Hmm | 1648 / 6.9   | 40kg   | 5800 |



Digital temperature control on each shelf



Power On/Off switch with jumper cords for each shelf





## GLO-RAY® PORTABLE FOOD WARMERS/CHIP DUMPS

With heat from above, below or both, Hatco Glo Ray® food warmers offer design flexibility without sacrificing food product quality. Ideal for use next to fry stations, drive-through windows, and service areas that require frequent and easy access, these units keep product at serving temperature and optimum quality.

### GR-FFB

This excellent Food Warmer/Chip Dump has a preset heated base that conducts heat from the bottom while an adjustable infrared element heats from above.

A swing-away top provides fast and easy access to food pans.

Weight: 12Kgs

Dimensions: 324 x 610 x 508mm

Electrical: 750 Watts, 3 amp. supplied with corded 10amp plug.

**LIST PRICE EA.        \$2080**



### GMFFL

Hatco's latest Portable Food Warmer has a sleek rounded design and its black colour finish fits into any decor. This portable Food Warmer has heat and light from above in powder-coat black and comes with a sign holder on the front lower panel (sign not included) to maximise sales potential.

Suits 1/1 Gastronorm pan 100mm deep (not included).

Weight: 9.2Kgs

Dimensions: 329 x 644 x 445mm

Electrical: 610 Watts, 2.5 amp supplied with corded 10amp plug.

**LIST PRICE EA.        \$725**





## GLO-RAY® PORTABLE FRY STATIONS & MULTI PRODUCT

Designed with ample handling space between the heat source and the holding area to empty baskets, Glo-Ray Fry Holding Stations maintain 'just made' food temperatures. Ceramic elements direct radiant heat from above, while a preset thermostatically controlled heated base (adjustable on the MPWS-36) maintains uniform holding temperature from below. The slotted holding bin allows the rising heat to envelop the food, preventing soggy product. A sectional divider permits holding of multiple products simultaneously.

**A range of options are available to customise each model to suit your own operation. Call your FSM representative.**

### GRFHS-21

Glo-Ray Portable Fry Station  
Dimensions 540 x 700 x 550mm  
Weight: 30Kgs  
Electrical: 1200watts, 5 amp.  
Supplied corded with a 10amp plug.

**LIST PRICE EA.        \$6995**



Shown With Optional Fry Ribbon

### MPWS-36 with MPWS-36 BIN

Glo-Ray Multi-Product Warming Station – the ultimate in hot fried food holding with six thermostatically controlled high power overhead ceramic heating elements and base element complemented by food grade teflon coated incandescent lamps for enhanced product display.

Choose from a wide range of optional extras including pleated ribbons, angled risers, bag and tong holders and fry bin inserts to customise the warming station for your operation. Unit comes standard with MPWS-36BIN accessory (Full Fry Bin insert; drip tray, perforated insert, three dividers) and detachable side panel insert for left or right installations.

Dimensions: 947 x 626 x 832mm  
Weight: 79Kgs  
Electrical: 3075watts, 13 amp.  
Supplied corded with 15amp plug.

**LIST PRICE EA.        \$9890**



Shown With Optional Scoop Holder



## HIGH WATT 4 SLOT POP-UP TOASTER 1 OR 2 SIDED TOASTING!

**TPT-230-4-10 up to 160 toast slices per hour**  
Perfect for self-serve areas, care facilities and light-medium volume applications.

The Hatco Pop-Up Toaster provides even golden toasting of a variety of bread products.

Durable stainless steel housing

Four self-centering slots (32mmW)

Two toasting controls with bagel/bun button for **one-sided** toasting

Removable crumb tray.

Two separate toasting controls

This productive and versatile unit enables the toasting of two lots of two slices of bread individually or together.

Electrical: 2.25Kw, 9.5 amps. Supplied with 10amp plug.

Dimensions: 378 x 330 x 235 mm

Weight: 8Kgs



**LIST PRICE EA. \$995**

Pop Up Toaster with either two lots of two or four slices toasted simultaneously.

## Are You Buying the Right Commercial Toaster for Your Foodservice Operation?

What makes someone the “toast of the town?” Typically, it’s because they’re pretty incredible (or toast-worthy). But funny enough, the saying works for toast itself.

There’s nothing quite like a slice of hot, buttered toast; the comfort-food meter is off the charts (especially if you add a little cinnamon and sugar). Breakfast isn’t complete without a side of crispy toast or a delicious bagel — and a BBQ pork sandwich, BLT or cheeseburger doesn’t measure up without a crisped bun. Toasted products are a staple for almost every operation out there.

### What to know about pop-up toasters

The benefits of a pop-up toaster:

A pop-up toaster is one of the most common types of toasters, and it’s also the least expensive on the market. Operation is simple with a standard dial to determine the preferred shade of toast, and a straightforward on-demand, push-down lever to “start” the unit up. These toasters typically use less energy and have a smaller footprint than other models.

Where a pop-up toaster shines

It’s familiar and easy-to-use controls make pop-up toasters perfect for front-of-the-house operations such as continental breakfasts, cafeterias or buffets. These settings (as well as coffee shops, small diners, and other establishments that demand less volume of toasted products) are the perfect candidates for a pop-up toaster. Look for a well-crafted, durable toaster with a removable crumb tray for easy cleanup. And longer, wider slots should be considered for increased versatility to toast items like bagels and hoagie buns. Lastly, if you plan to use a pop-up toaster in a front-of-house capacity, be aware of the aesthetics and choose one that not only functions well but also looks great.





## TOAST-MAX CONVEYOR TOASTER

The Hatco Toast-Max entry-level conveyor toaster offers the flexibility and performance to perfectly toast bread and buns fast. Utilising conveyor speed, not temperature, to determine toasting colour, this allows for instant adjustment of toasting time to maintain quality.

### TM-10H up to 6 slices/minute

4 position toast selector switch: off / toast / buns / standby mode.  
89mm clearance to accommodate high profile bread products.  
Easy-to-load rack with front or rear discharging.  
V-shaped reflectors help capture and redirect heat.  
Long lasting serpentine metal sheathed heating elements.  
102mm adjustable legs.  
Pilot light signals unit is in operation.  
Discharge & crumb trays are removable.  
Electrical: 1900watts, 8 amps. Supplied with 10amp plug.  
Dimensions: 368 x 387 x 419 mm  
Shipping weight: 19Kgs



LIST PRICE EA.        \$2070

### TM3-10H/BLACK

*Colourguard® sensing system* assures toast uniformity  
Power-save mode with indicator light saves energy during off-peak period  
Bread and bun toast options  
300-400 slices per hour toast capacity  
2" and 3" opening height  
Built-in fan provides cool surface temperature

Electrical: 1900watts, 8 amps. Supplied with 10amp plug.  
Dimensions: 368 x 411 x 535 mm  
Shipping weight: 20Kgs



LIST PRICE EA.        \$2995



## TQ SERIES HIGH WATT CONVEYOR TOASTERS

The Hatco High Watt Conveyor toasters toast high moisture content bread product to a rich golden colour. Sheathed heating elements are featured in all models. Toast-Qwik models have a conveyor feed guide and front or rear discharge with toast tray.

This provides the flexibility and performance to perfectly toast bread products. The exclusive **Colourguard® sensing system** monitors cabinet temperature and adjusts conveyor speed during high usage periods to assure uniform toast, improving customer satisfaction and reducing waste.

Power save mode conserves energy and saves money and the insulation and interior fan provide cooler surface temperatures.

### TQ3-500H TOAST-QWIK

**up to 500 toast slices/hour**

Touch screen controller - easy to see and use

Twelve programmable settings

USB port for software updates. Black finish standard.

Programmable power save function.

Unique toast delivery rack moves toast to the storage tray each and every time.

Suitable for front discharge with tray extended.

Exclusive **Colourguard® sensing system** controls toast quality

Toasts bread, buns, muffins and sandwiches.

Electrical: 2.22 kW, 9.3A. Supplied corded with 10 amp plug.

Dimensions: 373W x 524D x 435H mm

Delivery tray extends to 591 mm total depth

Height of opening 76mm

Weight: 25Kgs

**LIST PRICE EA. \$5920**

**DIGITAL PROGRAMMABLE MODEL**  
With Touch Screen control and Exclusive **Colourguard** technology maintains toast colour



### TQ-805 TOAST-QWIK

**up to 600 toast slices/Hour**

Suitable for front or rear discharge.

Exclusive **Colourguard® sensing system** controls toast quality

Toasts bread, buns, muffins and sandwiches.

Electrical: 3.6 kW, 15A. Supplied corded with 15 amp plug.

Dimensions: 368W x 578D x 422H mm

Weight: 28Kgs

Includes tray extensions.

Rear tray extends 165 mm.

**LIST PRICE EA. \$7500**

**Exclusive Colourguard** technology maintains toast colour



### TQ2-SECURITY COVER

Hinged Control Cover to suit TQ-805 units, can be retro fitted.

**LIST PRICE EA. \$260**



**Optional TQ2-Security Cover for TQ805 Model Toaster**



## TQ SERIES HIGH WATT **CONVEYOR** TOASTERS

### TQ-1800H TOAST-QWIK

**up to 1200 toast slices/hour**

Suitable for front or rear discharge.

Exclusive **Colorgard®** system controls toast quality by constantly monitoring toasting chamber temperatures and adjusting conveyor speed automatically.

Toasts bread, buns, muffins and sandwiches.

Adjustable Upper & Lower Heating Elements,

Power-Save Mode,

367mm WIDE throat

Electrical: 4.65 kW, 20 amp. Supplied unplugged.

Dimensions - 470 x 578 x 422mm

Includes tray extensions.

Rear tray extends 165 mm

Shipping Weight 33Kg

**LIST PRICE EA.**

**\$7995**

**MASSIVE  
PERFORMANCE  
with Exclusive  
Colorguard technology  
that maintains  
toast colour**



TQ Series Conveyor Toasters provide total control of the toasting of bread products. Individual controls are provided for top heat, bottom heat, conveyor speed and a stand-by switch to maximise quality and throughput. Colorgard sensing technology maintains toast quality through quiet or busy serving times. For those situations where you need to avoid patrons adjusting these controls unnecessarily, choose the TQ2 Security Cover for the TQ-805 Model.

The exclusive **ColorGuard® sensing system** monitors cabinet temperature and adjusts conveyor speed during high usage periods to assure uniform toast, improving customer satisfaction and reducing waste.







## PANINI GRILL

The Hatco® Panini Grill will help expand your menu and your sales. Available with a grooved (on request) or flat surfaces to accommodate all of your grilling needs. Perfect for making anything from sandwiches, tortillas and quesadillas to chicken and steak. Basically anything that can be grilled can be done right on your countertop without having to have a dedicated grill space. Digital control for both time and temperature for simple operation. A great addition to any kitchen set up.

### PG14F-1

Adjustable time/temperature controls enable operators to cook continuous, consistent quality products

Exclusive heating elements provide exceptional heat distribution throughout the entire cooking plate, ensuring even cooking of each product

Compact design is suitable for any location and stainless steel frame provides durability and easy cleaning

Can use on products up to 76mm thick

Maximum temperature of 260°C

Comes with a scraper and removable grease trough for easy clean up between uses

Convenient handles on either side of unit make it easy to move from one location to another

**LIST PRICE EA.      \$3990**





## PLATE WARMER

Hatco's PW Plate Warmer is designed to hold easily accessible pre-heated serving plates, as serving hot food on pre-heated plates helps extend the holding times of most foods.

### PWC-12/BLACK

Doorless, open design allows for easy retrieval, loading and cleaning.  
Can hold 25 plates up to 305 mm in diameter.  
Features a power On/Off switch and a covered digital temperature control with an adjustable range of 40°C to 50°C.  
Energy efficient LED lighting illuminates the interior from the top.  
Ability to daisy-chain up to three units (do not stack)  
Available as countertop or wall mounted.  
Electrical: 240 volt, 463 watts, supplied with 10amp plug, 1829mm power cord  
Dimensions - 427 x 441 x 568mm  
Opening Dimensions - 320 x 400mm  
Shipping Weight 29Kg

**Doorless design with a heated air curtain system**



**LIST PRICE EA.        \$2920**



## HATCO FREE STANDING DRAWER WARMERS

Available in 1, 2 & 3 drawer freestanding models built of rugged stainless steel with durable nylon drawer rollers, 12-gauge stainless steel slides and heavy-duty hardware in Standard or Narrow model to suit your kitchen space. *Unique features include:*

ALL drawers have an individual on/off switch, thermostatic control and adjustable sliding vents for humidity control providing superior quality control and versatility.

Each drawer has the capacity to accept a pan 1/1x150mm deep or 2x1/2 or 3x1/3. (Pans not included).

Supplied with 102mm legs, 1829mm cord and 10A plug. Castor option available on ALL models.

**HDW-1**  
1-drawer model  
749W x 575D x 279Hmm (excluding legs)  
Supplied with cord and 10 amp plug.  
450watts / 2 Amp. Weight: 44Kg  
**LIST PRICE EA. \$5580**



**HDW-2**  
2-drawer model  
749W x 575D x 537Hmm (excluding legs)  
Supplied with cord and 10 amp plug.  
900watts 3.8 Amp. Weight: 76Kg  
**LIST PRICE EA. \$9460**



**HDW-3**  
3-drawer model  
749W x 575D x 794Hmm (excluding legs)  
Supplied with cord and 10 amp plug.  
1350watts / 5.7 Amp. Weight: 106Kg  
**LIST PRICE EA. \$13550**



Shown With Optional Casters

**HDW-CASTER 2"**  
**Option All Models**  
Hatco Heavy Duty Castor kit, 51mm Diameter  
Add mobility to your drawer warmer with the Hatco **HDW-CASTER 2"** option. These castors easily change-over with the standard legs, enabling moving for routine cleaning/ maintenance etc. (PACK OF 4)  
**LIST PRICE EA. \$455**



## HATCO FREE STANDING NARROW DRAWER WARMERS

**HDW-1N**  
1-drawer Narrow model  
530W x 686D x 279Hmm (excluding legs)  
Supplied corded with 10 amp plug.  
450watts / 2 Amp. Weight: 44Kg  
**LIST PRICE EA. \$5580**



**HDW-2N**  
2-drawer Narrow model  
530W x 686D x 537Hmm (excluding legs)  
Supplied corded with 10 amp plug.  
900watts / 3.8 Amp Weight: 76Kg  
**LIST PRICE EA. \$9460**







## HATCO FREE STANDING DRAWER WARMER

Available in 1, 2 & 3 drawer freestanding models built of rugged stainless steel with durable nylon drawer rollers. *Unique features include:*

- Top-of-the-unit Touchscreen Controller is positioned at an angle for greater visibility
- Controller allows individual temperature control and hold timer per drawer with both visual and audio alerts
- Robust stainless steel construction inside and out.
- Easy-to-clean seamless, interior core with snap out out side panels make this unit easy to service
- Each drawer has adjustable vents for varying moisture levels in individual drawers
- Drawer frame can accommodate varying pan configurations, including 1/1 GN, 1/3 GN, 1/3 GN up to 152 mm deep, with or without lids (pans not included).

### HDWTC-2

2-drawer model  
 622W x 650D x 573Hmm  
 Supplied on 51mm Castors  
 Add 38mm to depth for door handles  
 Supplied with cord and 10 amp plug.  
 766watts / 3.2 Amp. Weight: 81Kg

**LIST PRICE EA.      \$11650**



## HATCO DRAWERMAX® DRAWER WARMERS

**2 drawer freestanding model built with rugged construction and heavy-duty hardware to keep variety of foods hot and fresh until served. *Unique features include:***

- ALL drawers have an individual on/off switch and independent temperature control, and adjustable vents for humidity control providing superior quality control and versatility.
- Includes two full-size stainless steel 150mm food pans
- Supplied with 102mm legs, 1829mm cord and 10A plug. Castor option available.
- Easy to clean,

### HDM-2

2-drawer model  
 749W x 576D x 614Hmm (including legs)  
 Supplied with cord and 10 amp plug.  
 984watts / 2 Amp. Weight: 74Kg

**LIST PRICE EA.      \$4850**



Black powdercoated exterior



## GLO-RAY® DECORATIVE CARVING STATIONS

The Glo-Ray Decorative Carving Stations are the ideal way to display, hold and serve food and to extend food holding times during serving periods. With a wide range of options and styles, Hatco have a unit that will complement your servery and decor perfectly with reliable quality.

### DCS400-1-BN

Freestanding overhead height adjustable heat lamp supported by a sturdy 203mm square base.

527D x Variable Height 864-1168Hmm

Shown in Bright Nickel.

Also available in *Bright Brass and Antique Bronze*.

Weight: 15Kg

Supplied corded with 10amp plug. 250watts 1 Amp.

**LIST PRICE EA. \$3480**



### DCSB400-2420-1-NSBN

Overhead height adjustable heat lamp supported by a rectangular Swanstone heated base with sneeze guard.

608W x 506D x Height 864 - 1168Hmm.

Shown in Night Sky Base with Bright Nickel posts and lamp.

Also available in *Bright Brass/Antique Bronze post and lamp and Gray Granite/Bermuda Sand decorative base stone colours*.

Weight: 48Kg

Supplied corded with 10 amp plug. 750watts / 3.2 Amp.

**LIST PRICE EA. \$8300**



### DCSB400-3624-2-GGBN

Dual overhead heat lamps - height adjustable, supported by a rectangular Swanstone heated base with sneeze guard.

911W x 610D x Height 864 - 1168Hmm.

Shown in Bright Nickel post and lamp and Gray Granite base.

Also available in *Antique Bronze/Bright Brass post and lamp and Bermuda Sand/Night Sky decorative base stone colours*.

Weight: 70Kg

Supplied corded with 10 amp plug. 1300watts / 5.5Amp.

**LIST PRICE EA. \$11980**



## COLOUR SWATCHES



Plated Colours:

Bright Nickel, Bright Brass and Antique Bronze



Stone Colours:

Gray Granite, Bermuda Sand and Night Sky



## HATCO PASTA COOKERS

**BOIL, STEAM, WARM**  
 The multi-purpose HEAT-MAX well offers the flexibility of a food warmer, soup kettle, bain marie heater, steamer and pasta cooker all in one!  
 With a range of temperature settings, HEAT-MAX can boil pasta and soup noodles, steam dim sum, keep food warm, hold soups, curries, gravies and toppings at safe serving temperatures.

**RCTHW2-3 (NEW MODEL)**  
**Heat-Max Rectangular Single Heated Well**  
 to take 1/1 Gastronorm pan (not supplied).  
 Three settings, low/medium/high, each with it's own temperature setting range of 40-65°C, 65-80°C and 80-95°C.  
 Electronic control panel  
 Energy saving Low Power mode  
 Convenient Drain control  
 Also available in Built-in Model with remote.  
 Electrical: 3Kw, 12.5 amps.  
 Supplied corded with 15amp plug.  
**LIST PRICE EA.            \$1740**



**COUNTERTOP**  
**RCTHW2-6\***  
**Heat-Max Pasta Cooker**  
**Free Standing**  
 to take 1/1 Gastronorm pan (not supplied).  
 Touch panel for three temperature set points:  
**LOW:** 40-65°C **MED:** 65-80°C  
**HIGH:** 80-95°C  
 Energy saving Low Power mode  
 Convenient Drain control  
 Autofill & Pasta Plate  
 Insulated stainless steel design  
 Electrical: 6Kw, 25 amps.  
 No cord or plug supplied.  
**LIST PRICE EA.    \$3100**

**BUILT-IN**  
**RCTHW2-6B\***  
**Heat-Max Pasta Cooker**  
**Built-In**  
 to take 1/1 Gastronorm pan (not supplied).  
 Touch panel for three temperature set points:  
**LOW:** 40-65°C **MED:** 65-80°C  
**HIGH:** 80-95°C  
 Energy saving Low Power mode  
 Convenient Drain control  
 Autofill & Pasta Plate  
 Insulated stainless steel design  
 Electrical: 6Kw, 25 amps.  
 No cord or plug supplied.  
**LIST PRICE EA.    \$3200**

### SPECIFICATIONS

| MODEL     | OUTER DIMENSION MM | Kw  | SHIP WEIGHT |
|-----------|--------------------|-----|-------------|
| RCTHW2-3  | 368W X 582L x 290H | 3.0 | <b>12KG</b> |
| RCTHW2-6  | 368W X 582L x 290H | 6.0 | <b>14KG</b> |
| RCTHW2-6B | 368W X 582L x 302H | 6.0 | <b>14KG</b> |

\*New code 1 FEBRUARY 2024





## ACCESSORIES

### RCTHW-BASKET

RCTHW Stainless Steel Noodle Basket  
125mm diameter  
(six required per unit)

LIST PRICE EA.        \$75



### RCTHW-PC

Pasta Cooker Tray

LIST PRICE EA.        \$510



RCTHW-1E shown with optional Pasta Cooker Tray & Noodle Baskets

## 3CS-9B SANITISING SINK HEATER **Balanced three phase**

Maintaining a continuous supply of sanitising rinse water without taking up valuable space, the 3CS makes manual ware-washing faster and more convenient. Designed to fit under the sink, the 3CS is perfect for three or four compartment sinks, pot and pan sinks and bar sinks. Drain may be plumbed to open-sight waste drain.

### 3CS-9B SANITISING SINK HEATER

Weight: 15Kgs. Electrical: 9 Kw, 3 phase.  
Supplied uncorded and unplugged.  
Dimensions: 203W x 435D x 321Hmm

LIST PRICE EA.        \$6990



Pictured: 3CS-9 with optional temperature monitor



## HATCO BUILT-IN HEATED WELLS

Hatco Built-In Heated Wells hold heated foods at safe serving temperatures. Compared to other models, these Hatco units offer larger drains with flat drain screens, more consistent holding temperatures through superior element design, heavier stainless steel construction, easier-to-service design for quick-change of components, and a remote thermostat with separate power switch. Suitable for wet or dry operation.

All units are supplied with a control panel and connected with a 918mm flexible conduit for remote mounting and include a 3/4" NPT drain fitting.

### BUILT-IN RECTANGULAR HEATED WELL - FULL SIZE

#### HWB-FULD

Heated Well with drain – 1/1 Gastronorm.

Dimensions: 348W x 553D x 218Hmm

Controller dimensions: 161W x 92D x 196Hmm

Electrical: 1.2kw, 5 amp

Weight: 10Kg

Drain: 3/4" NPT fitting

**LIST PRICE EA.            \$1810**



Remote control with 918mm conduit for convenient fitting

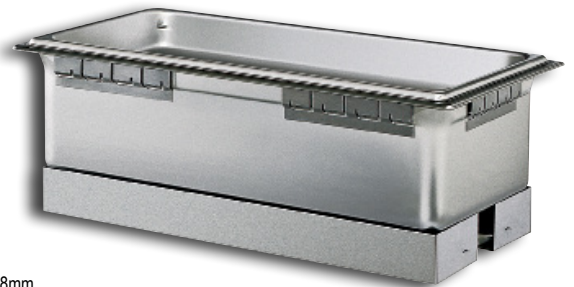

(Pictured with accessory food pan).

### BUILT-IN ROUND HEATED WELLS with drain fitting

| CODE      | DESCRIPTION                                  | KW    | AMP  | WT  | \$   |
|-----------|--|-------|------|-----|------|
| HWB-4QTD  | 3.8Litre (4 Quart) Heated Well with drain.   | 0.6kw | 2.5A | 5Kg | 1800 |
| HWB-7QTD  | 6.6Litre (7 Quart) Heated Well with drain.   | 0.6kw | 2.5A | 5Kg | 1850 |
| HWB-11QTD | 10.1Litre (11 Quart) Heated Well with drain. | 0.6kw | 2.5A | 5Kg | 1860 |

All wells come with 3/4" NPT drain fitting.



(Pictured with accessory pans see below).

### OPTIONAL PAN INSERTS & LIDS (not supplied with wells above)

| CODE         | DESCRIPTION                                   | \$  |
|--------------|---|-----|
| 4QT-PAN&LID  | 4 Quart (3.8L) Round Well and Notched Lid.    | 350 |
| 7QT-PAN&LID  | 7 Quart (6.65L) Round Well and Notched Lid.   | 400 |
| 11QT-PAN&LID | 11 Quart (10.41L) Round Well and Notched Lid. | 450 |





## HATCO SALAMANDERS

Hatco's Salamander range is specially designed for versatility in the kitchen with the capabilities to cook, grill, and reheat food. With the patented movable heat unit housing, maximum thermal transfer is achieved and maximum power is only consumed whilst actually in cook mode. The unparalleled start-up speed is a result of Hatco's "INSTANT ON" heating elements located in the upper housing. Hatco® Salamanders offer unrivalled energy efficiency and easy operation to suit the most demanding requirements - of fine dining restaurants to fast food outlets.

### TMS-1H THERMAX SALAMANDER

**Movable upper housing to reduce the heat loss to food areas.**

- The high powered heating elements are ready for use within 10 seconds.
- Two sets of independently controlled heating element sections give the benefits of flexibility and energy conservation.
- Cook mode selection switch controls left, right or both locations.
- Includes a hold mode switch that reduces power to 25% and keeps food at proper serving temperatures.
- Unit can be placed on a counter-top or mounted to any non-combustible wall with appropriate rigidity.
- Unit comes standard with grill, drip pan and wall mounting bracket.
- Weight: 70Kgs. Dimensions: 600W x 503D x 515Hmm.
- Electrical: 4Kw 17.4 amp. Supplied with cord but no plug.

**LIST PRICE EA.        \$5890**



### TMS2-1H SALAMANDER - DIGITAL CONTROL

**Optimum temperature is reached instantly and efficiently when food products are placed on the grill plate.**

- Instant-On heating elements located in the upper housing
- Plate detection feature activates the Instant-On heating elements when a plate (500g) is placed on the grill plate, and deactivates when removed
- Heating elements are only on when in use, eliminating residual heat in the kitchen
- Made of stainless steel for easy cleaning and durability
- Can be placed on a countertop or wall-mounted
- Hold mode could be adjusted to save 25-50% power
- Adjustable upper housing giving 170mm of vertical movement
- Flat, tactile control panel
- Ship Weight: 80Kgs Overall Dimensions: 630W x 505D x 568Hmm.
- Electrical: 4.1kw 17.2 amp. Supplied with cord but no plug.

**LIST PRICE EA.        \$6890**





Tight for space and storage of meals for peak periods?

JACKSTACK offers so many advantages in storage, preparation and serving, you'll wonder how you did without it.

JACKSTACK is the world leader in the efficient storage and transport of up to 104 plates in minimum time from kitchen to storage or banquet areas.

Generous 150mm diameter wheels allow for easy maneuverability of the Jackstack anywhere, and the plate racks are easily adjustable to suit all applications - even mixing plate sizes.

Models provide 50mm spacing between plate supports and they can be loaded and unloaded from four sides, and carry up to 400 empty plates to the dishwasher.



Designed by Chefs, for chefs

## JACKSTACK Model JS104

Makes it possible to stack between 12 to 104 plates of any size. Different size plates can be accommodated by adjusting the racks to suit. (For pizza applications, a special 'P' model longer arm unit is available at extra cost).

The unit comes with four castors (two with brakes), and easy to follow assembly instructions.

**Assembled Dimensions:** 600W x 600D x 1790Hmm

**Shipping Dimensions:** 800W x 620D x 300Hmm

**Weight:** 28Kg

| CODE  | CAPACITY   | SPACING | DIMENSION       | \$   |
|-------|------------|---------|-----------------|------|
| JS104 | 104 plates | 50mm    | 600x600x1790mmH | 3140 |



## JACKSTACK OPTIONS

### Thermocover for JS104

Preserves 72-104 plates in transit with warm or cold food.

Made of industrial High Tenacity PES fabric, with polyester fibre centre layer.

Includes special arm extensions.

Complete with 4 horizontal and 4 vertical zippers.

Washable - hygienic in use.

Dimensions: 720 x 720 x 1590Hmm.

Shipping Dimensions: 430 x 310 x 260Hmm

Weight: 6Kg

| MODEL   | DESCRIPTION                                    | \$   |
|---------|--|------|
| JS104TC | Thermal covers available on request (pictured) | 1980 |
| JS901PC | Non thermal covers for 104 plate unit          | 390  |



MODEL JS104TC Thermal Cover

The Jetstream range of quality tapware and pre-rinse units heralds a new era of reliable, quality tapware to the Australian market with an industry leading FIVE YEAR on-site parts and labour warranty\* – designed by professionals with the features you would expect for your kitchen.

Features like 256mm swing faucet on full height pre-rinse models, six star Wels rated spray gun and quality construction with 100mm levers with a choice of 100 or 200mm flick mixers and more.

Watermark approved and Wels rated to comply with all Australian regulations, and supplied with our exclusive FIVE YEAR on-site parts and labour warranty\* for real peace of mind.

All units come packed with full instructions, fittings and hose connections (model dependant).

### DECK MOUNT PRE RINSE MODELS

#### JET1500D DECK MOUNT

Deck Mount Pre Rinse, complete with wall bracket, 256mm add on swing faucet, 1/4 turn 100mm lever operated ceramic disc taps and **6 Star** rated spray gun, 4 Star rated pot filler as shown. Single hole mount. Overall height: 1073mm. Hose length 845mm

LIST PRICE EA.           **\$1050**  
**6 BUY PRICE EA.       \$1030**  
**12 BUY PRICE EA.      \$1000**



#### JET1500DLH DECK MOUNT *LOW HEIGHT*

Deck Mount Pre Rinse, Low Height Model, complete with wall bracket, 1/4 turn 100mm lever operated ceramic disc taps and **6 Star** rated spray gun, 4 Star rated pot filler as shown. Single hole mount. Overall height: 734mm. Hose length 845mm.

LIST PRICE EA.           **\$935**  
**6 BUY PRICE EA.       \$920**  
**12 BUY PRICE EA.      \$900**



(Deck Mount units continued...)

\* Five Year on-site warranty covers manufacturing defects, and excludes faulty installation, sensitivity adjustments on electronic models, failure to instal pressure limiting devices where required.

### JET1200D DECK MOUNT

Deck Mount Pre Rinse, complete with wall bracket, 256mm swing faucet, single lever flow and temperature control, and **6 Star** rated spray gun, 4 Star rated pot filler. Single hole mount. Overall height: 960-1030mm. Hose length 845mm.

LIST PRICE EA. **\$980**

6 BUY PRICE EA. **\$965**

12 BUY PRICE EA. **\$955**

Stainless  
Steel



### Jetstream features

- NEW stainless steel options are LEAD FREE.
- Pre-rinses come in showroom ready boxes
- Pre-rinses are assembled for easy installation
- NEW products - towel and soap dispenser
- Five year onsite parts and labour warranty

\* Five Year on-site warranty covers manufacturing defects, and excludes faulty installation, sensitivity adjustments on electronic models, failure to instal pressure limiting devices where required.



### WALL MOUNT PRE RINSE MODELS

#### JET1500W WALL MOUNT EXPOSED BREECH

Wall Mount Pre Rinse, complete with wall bracket, 256mm Add on swing faucet, 1/4 turn 100mm lever operated ceramic disc taps and **6 Star** rated spray gun, 4 Star rated pot filler as shown. Two hole mount. Hose length 845mm. Overall height: 1023mm.

LIST PRICE EA. **\$1415**  
 6 BUY PRICE EA. **\$1400**  
 12 BUY PRICE EA. **\$1390**



#### JET1500WCB WALL MOUNT CONCEALED BREECH

Wall Mount Pre Rinse, complete with wall bracket, 256mm Add on swing faucet, 1/4 turn 100mm lever operated ceramic disc taps **6 Star** rated spray gun, 4 Star rated pot filler as shown. Three hole mount. Hose length 845mm. (Breech by others). Overall height: 713mm.

LIST PRICE EA. **\$1220**  
 6 BUY PRICE EA. **\$1200**  
 12 BUY PRICE EA. **\$1195**



\* Five Year on-site warranty covers manufacturing defects, and excludes faulty installation, sensitivity adjustments on electronic models, failure to instal pressure limiting devices where required.

### DECK MOUNT FLICK MIXER MODELS

#### JET5200D DECK MOUNT FLICK MIXER 200mm swing spout

Deck Mount Flick Mixer, complete with 200mm Swing Spout, **4 Star** rated, one hole mount, complete with flexible fittings. Cutout size: 35-36mm Dia.

LIST PRICE EA.           **\$225**  
**6 BUY PRICE EA.        \$220**  
**12 BUY PRICE EA.       \$215**

**Stainless Steel**



#### JET5100D DECK MOUNT FLICK MIXER 100mm spout

Deck Mount Flick Mixer, complete with 100mm Fixed Spout, **4 Star** rated, one hole mount, complete with flexible fittings. Cutout size: 35-36mm Dia. Operating water pressure Min 50kPA, Max 350kPA.

LIST PRICE EA.           **\$230**  
**6 BUY PRICE EA.        \$225**  
**12 BUY PRICE EA.       \$220**

**Stainless Steel**



#### JET6000 THERMOSTATIC MIXING VALVE 15/20mm

Critical for supplying safe/desirable water temperatures to a Hands Free or Time Flow tapset. Output temperature range 35-50°C.

LIST PRICE EA.           **\$380**  
**6 BUY PRICE EA.        \$370**  
**12 BUY PRICE EA.       \$360**

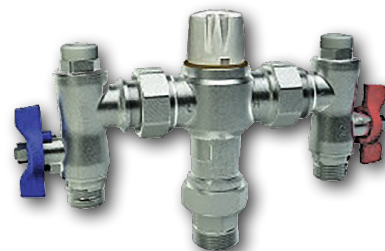

\* Five Year on-site warranty covers manufacturing defects, and excludes faulty installation, sensitivity adjustments on electronic models, failure to instal pressure limiting devices where required.

### HANDS FREE & TIME FLOW MODELS

#### JET4001D DECK MOUNT HANDS-FREE SENSOR TAP

Modern Deck Mounted Hands Free Sensor Tap, single hole mount, complete with flexible fittings, downward facing sensor, Mains and battery backup, 6 Star rating. Includes one connection tail and hardware. Stop taps recommended (not supplied).

**LIST PRICE EA.**                 **\$795**  
**6 BUY PRICE EA.**             **\$790**  
**12 BUY PRICE EA.**          **\$780**



#### JET4003W WALL MOUNT HANDS-FREE SENSOR TAP

Modern Wall Mounted Hands Free Sensor Tap, single hole mount, complete with flexible fittings, downward facing sensor, Mains and battery backup, 6 Star rating. Includes one connection tail and hardware. Stop taps recommended (not supplied).

**LIST PRICE EA.**                 **\$800**  
**6 BUY PRICE EA.**             **\$790**  
**12 BUY PRICE EA.**          **\$780**



#### JET745D DECK MOUNT TIME FLOW TAP

Deck mounted Time Flow Tap. 15 Seconds. Single hole mount, 6 Star rating. Includes one connection tail and hardware.

Supplied with Blue Red and Yellow button.

**LIST PRICE EA.**                 **\$245**  
**6 BUY PRICE EA.**             **\$235**  
**12 BUY PRICE EA.**          **\$225**



\* Five Year on-site warranty covers manufacturing defects, and excludes faulty installation, sensitivity adjustments on electronic models, failure to instal pressure limiting devices where required.



### JET1100D LASER SENSOR

Digital sensor technology, low voltage, internal integrated sensor, hygiene flush programming available, single temperature (max 50°C). Battery and mains power. Recommended working pressure 350kPa

LIST PRICE EA.

\$1195

Stainless Steel



### JET2600W LASER SENSOR

Digital sensor technology, low voltage, internal integrated sensor, hygiene flush programming available, single temperature (max 50°C). Battery and mains power. Recommended working pressure 350kPa

LIST PRICE EA.

\$1195

Stainless Steel

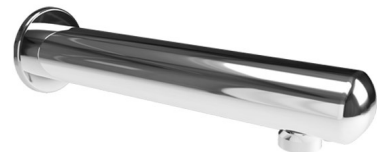

\* Five Year on-site warranty covers manufacturing defects, and excludes faulty installation, sensitivity adjustments on electronic models, failure to instal pressure limiting devices where required.

### KNEE OPERATED & CLEANERS SINK

#### JET780D KNEE OPERATED TIMER BASIN TAP SET

Includes deck mount fixed gooseneck outlet, 325mm lever / knee operated time-flow and connections. Six Star rated.

LIST PRICE EA. \$410



#### JET1836W CLEANERS SINK FAUCET SET with wall bracket support

Quality Wall mounted Cleaners Sink model with cable supported Spout and Bucket Hook. 4 Star rated.

LIST PRICE EA. \$1330



### POT FILLER

#### JET2047W WALL MOUNT POT & KETTLE FILLING FAUCET

double jointed with spout on-off control

Premium Pot filler with 457mm swing arm, double jointed, includes convenient on/off control on spout.

LIST PRICE EA. \$1155



\* Five Year on-site warranty covers manufacturing defects, and excludes faulty installation, sensitivity adjustments on electronic models, failure to instal pressure limiting devices where required.

### DECK MOUNT FAUCET/SINK SETS

#### JET3150D DECK MOUNT FAUCET WITH 180MM SPOUT

Deck Mounted 180mm Swing Faucet, with 100mm Lever operation, one hole mount, complete with flexible fittings. Ceramic cartridges, 1/4 turn levers, rugged construction and high quality finish. 4 Star rated.

LIST PRICE EA. **\$570**  
 6 BUY PRICE EA. **\$565**  
 12 BUY PRICE EA. **\$555**



#### JET3300DCB DECK MOUNT WITH 300MM SPOUT

Deck Mounted 300mm Swing Faucet, with Lever operation, concealed breech, three hole mount. Ceramic cartridges, 1/4 turn 100mm levers, rugged construction and high quality finish. 4 Star rated. (Breach by others). \*Whilst stocks last

LIST PRICE EA. **\$495**  
 6 BUY PRICE EA. **\$485**  
 12 BUY PRICE EA. **\$475**



(Tap detail common to all Concealed Breech models).

#### JET3180DCB DECK MOUNT WITH 180MM SPOUT

Deck Mounted 180mm Swing Faucet with Lever operation, concealed breech, three hole mount. Ceramic cartridges, 1/4 turn 100mm levers, rugged construction and high quality finish. 4 Star rated. (Breach by others). \*Whilst stocks last

LIST PRICE EA. **\$470**  
 6 BUY PRICE EA. **\$465**  
 12 BUY PRICE EA. **\$445**



\* Five Year on-site warranty covers manufacturing defects, and excludes faulty installation, sensitivity adjustments on electronic models, failure to instal pressure limiting devices where required.



### JET3000D

Deck Mounted 180mm Swing Faucet with lever tap. Lead free. Soft close operation. 400mm high. 4 Star rated.  
\*Whilst stocks last

**Stainless Steel**



**LIST PRICE EA.            \$295**  
**6 BUY PRICE EA.         \$285**  
**12 BUY PRICE EA.        \$270**

## WALL MOUNT FAUCET/SINK SETS

### JET3300WCB WALL MOUNT WITH 300MM SPOUT

Wall Mounted 300mm Swing Faucet, with Lever operation, concealed breech, three hole mount. Ceramic cartridges, 1/4 turn 100mm levers, rugged construction and high quality finish. 4 Star rated. (Breech by others). \*Whilst stocks last

**Satin Chrome**



**LIST PRICE EA.            \$550**  
**6 BUY PRICE EA.         \$540**  
**12 BUY PRICE EA.        \$530**

\* Five Year on-site warranty covers manufacturing defects, and excludes faulty installation, sensitivity adjustments on electronic models, failure to instal pressure limiting devices where required.

### NEW LOW LINE SERIES

#### JET3560D DECK MOUNT WITH 300MM SPOUT

Deck Mounted 300mm Swing Faucet Sink Mixer with Lever operation, one hole mount complete with flexible fittings, ceramic cartridges, 1/4 turn levers, brushed stainless steel. Wells Rated 4 star.

LIST PRICE EA. **\$590**  
 6 BUY PRICE EA. **\$580**  
 12 BUY PRICE EA. **\$570**



#### JET3550W DECK MOUNT WITH 180MM SPOUT

Deck Mounted 180mm Swing Faucet Sink Mixer with Lever operation, one hole mount complete with flexible fittings, ceramic cartridges, 1/4 turn levers, brushed stainless steel. Wells Rated 4 star.

LIST PRICE EA. **\$560**  
 6 BUY PRICE EA. **\$550**  
 12 BUY PRICE EA. **\$540**



#### JET3560W WALL MOUNT WITH 300MM SPOUT

Deck Mounted 300mm Swing Faucet with Lever operation, three hole mount, concealed breech, 1/4 turn 100mm levers, brushed stainless steel. (Breech by others). Wells Rated 4 star.

LIST PRICE EA. **\$770**  
 6 BUY PRICE EA. **\$760**  
 12 BUY PRICE EA. **\$750**



\* Five Year on-site warranty covers manufacturing defects, and excludes faulty installation, sensitivity adjustments on electronic models, failure to instal pressure limiting devices where required.

### DISPENSERS

#### JET8000 TOWEL DISPENSER

The surface-mounted towel dispenser is supplied with four mounting screws  
 Unit dispenses C-fold or multifold paper towels 64-97mm deep  
 Durable, heavy-duty product  
 Slots in cabinet indicate refill time  
 Stainless steel construction  
 Recommended for any commercial project

**LIST PRICE EA.            \$190**

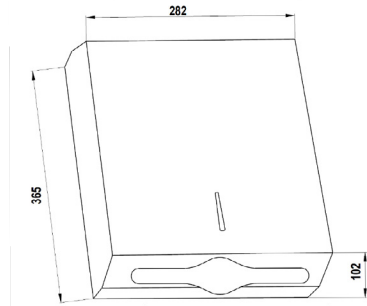

**Stainless Steel**

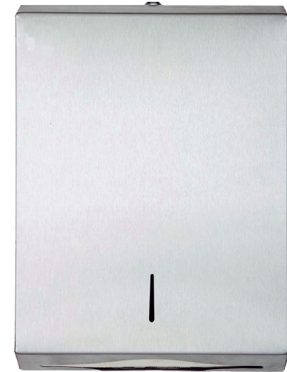

#### JET7000 SOAP DISPENSER

The dispenser is supplied with a mounting bracket fixed to the wall and the dispenser slides into the mounting bracket, so it is easily removed for rinsing.  
 Durable, heavy-duty product  
 Stainless steel  
 Recommended for any commercial project  
 Refillable from the top  
 Manually operated soap dispenser  
 Front inspection window

**LIST PRICE EA.            \$120**

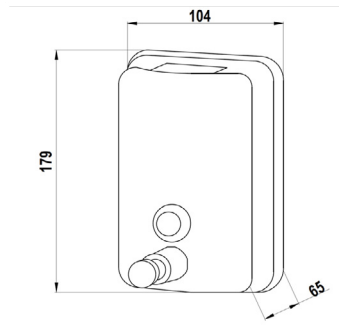

**Stainless Steel**





Jetstream Heavy Duty Retractable Hose Reels are manufactured to commercial grade standards with heavy gauge steel construction and springs/latches for reliable operation. Available in various hose lengths as well as stainless steel option (kHR 1035 Models). Positive latch system holds hose at desired length. Wall, ceiling or floor mount. All hoses are suitable for up to 82°C and up to 500kpa. On-site 13 month warranty\* on parts and labour.

## HEAVY DUTY HOSE REELS

### JET-1035-OSS-Y722

#### 11m HOSE

##### STAINLESS STEEL CONSTRUCTION

Open Hose Reel Assembly

11m (35') hose supplied with Y722 spray gun.

Shipping weight 17Kg

**13 MONTH WARRANTY\***

LIST PRICE EA.      \$2980

### JET-1035-O-Y722

#### 11m HOSE

##### GREY POWDER COATED

Open Hose Reel Assembly

11m (35') hose supplied with Y722 spray gun.

Shipping weight 17Kg

**13 MONTH WARRANTY\***

LIST PRICE EA.      \$2550

### JET-1050-O-Y722

#### 15.3m HOSE

##### GREY POWDER COATED

Open Hose Reel Assembly

15.3m (50') hose supplied with Y722 spray gun

Shipping weight 22Kg

**13 MONTH WARRANTY\***

LIST PRICE EA.      \$3995



\* 13 month parts and 13 month labour warranty covers manufacturing defects only.

## 297-SW16 VERTICAL CONTACT BUN TOASTER - COMPACT SIZE

When maximum throughput speed is essential, Prince Castle Vertical Bun Toasters offer up to 750 buns per hour capacity for venues that have high demand. The NEW 297-SW16 model is up to 20% smaller in footprint compared to previous models, and includes the 'Air Flapper' heat and energy saving device and new Front Safety Shield for operator safety and comfort.



297-5110 Top Mounting Bun Dresser  
LIST PRICE EA \$550

### 297-SW16

**Slim-Line Vertical Bun Toaster** – up to 750 Buns per hour.  
New Air Flapper increases bun temperatures by up to 3°C and saves energy.  
New operator heat shield provides greater operator safety.  
Adjustable platen temperature up to 304°C.  
Includes Teflon Kit, Air Flapper & Safety Shield.  
Dimensions: 515W x 590H x 206Dmm  
Weight: 32Kg  
Electrical: 1890W, 8Amp.

**LIST PRICE EA. \$5620**

## CTS-WCE SLIM-LINE VERTICAL TOASTER

Introducing Prince Castle's CTS-WCE Mini Slim-Line Vertical Contact Toaster. A revolutionary new design that increases toasting versatility, maximises space savings, and provides perfect caramelisation with the convenience of vertical contact toasting. The unique two-level platen design allows the operators to toast thicker bun crowns and thinner bun heels at the same time. The variable speed motor is adjustable to allow for toasting speeds up to 2200 buns per hour.

### CTS-WCE

**Sim-Line Vertical Bun Toaster** – up to 2200 Buns per hour.  
Small footprint of 514 x 184mm saves space  
Adjustable toasting time from 9-40 seconds to customise product  
Digital display and electronic controls make for precise and repeatable settings complete with wire belt  
Simple to remove conveyor makes cleaning quick and easy  
Dual compression adjustment knobs allow for maximum product flexibility  
Accommodates all buns up to 1397mm in diameter  
Heat Shield for cooler surfaces ensuring safer operation  
Durable stainless steel construction makes the product easy-to-clean and maintain  
Dimensions: 514W x 559H x 184Dmm  
Weight: 30Kg  
Electrical: 1500W, 6.25Amp.

**LIST PRICE EA. \$11005**



### 511-140

**Top Mounting Bun Dresser** – perfect solution to your buttering needs for CTS-WCE model only.  
Dimensions: 137W x 745H x 300Lmm  
Weight: 2Kg  
Electrical: 1500W, 6.25Amp.

**LIST PRICE EA. \$1250**



## PRINCE CASTLE DEDICATED HOLDING BINS - The benchmark WITH EXCLUSIVE RELI-A-TEMP HEATING TECHNOLOGY AND MENU TRAK TIMER SYSTEM.

### DHB24ACE (WAS DHB2PT-33) - 8 Pans

Two Cavity, **Pass Through Model** – each cavity equipped with rack system which holds four pans (eight required in total), four individually controlled heaters.

Timer bars on both sides of unit.

Dimensions: 838 W x 282 H x 358 D mm.

Weight: 55Kg

Electrical: 2.6kw 11Amp Supplied with 15 amp plug.

Order Pans separately.

**LIST PRICE EA.      \$10795**



Call for details on other configurations to suit your kitchen/plans.

### DHB2SS-20 - 4 Pans

Two Cavity, **Single Sided Model** – each cavity equipped with rack system which holds two pans (four required in total), two individually controlled heaters.

Timer bar on front side of unit.

Dimensions: 500 W x 282 H x 358 D mm.

Weight: 24Kg

Electrical: 1550Watts 6.6 Amp, Supplied with 10 amp plug.

Order Pans separately.

**LIST PRICE EA.      \$8380**



## PANS FOR USE IN DHB CABINETS - save \$\$ with the 12 pack

| CODE      | DESCRIPTION                               | \$ each | \$ 12 pack |
|-----------|---|---------|------------|
| 30860HH13 | Double Handled Amber Pans, 1/3 size, 64mm | 75      | 860        |
| 30860H13  | Single Handled Amber Pans, 1/3 size, 64mm | 73      | 840        |



Double Handle Pan for pass-through operations



Prince Castle are innovators in food preparation and holding technologies, and offer quality solutions in many areas of the commercial kitchen. From Tomato/Citrus slicers to high speed vertical bun toasters to the industry standard Product Holding Units (PHUs) used in so many well known QSR outlets world-wide.

## HEAVY SAUCE PORTION DISPENSERS - 580 SERIES

Commercial-duty sauce dispenser guns available in a choice of portion size/volume.

Suitable for most heavy sauces. Supplied without bottles.

Dispenser: 262 x 193mm. Weight 1.3Kg

| CODE     | PORTION SIZE        | \$  |
|----------|---------------------|-----|
| 580-NMCC | 1/3 fl.oz (9.8ml)   | 245 |
| 581-NMCC | 1/2 fl.oz (14.8 ml) | 245 |
| 582-NMCC | 2/3 fl.oz (19.5 ml) | 210 |
| 583-NMCC | 1 fl.oz (29.5 ml)   | 240 |



When ordering sauce dispensers, order #136-1 bottles if not using pre-packaged sauces.

## ACCESSORIES FOR 580 SERIES HEAVY SAUCE DISPENSERS

### Dispenser Bottles (case of 9) re-useable.

Each bottle is supplied with a nozzle for thinner sauces and a flexible valve for chunky sauces. Each bottle comes with end cap.

| MODEL | DESCRIPTION                             | \$  |
|-------|---|-----|
| 136-1 | DISPENSER BOTTLES (CASE OF 9) RE-USABLE | 155 |



### Bottle Storage Tray (Shown with bottles – supplied separately)

| MODEL | DESCRIPTION         | \$  |
|-------|---------------------|-----|
| 155   | BOTTLE STORAGE TRAY | 140 |

## SAUCE & MUSTARD DISPENSERS

### Commercial-Duty Sauce and Mustard dispenser guns. Enjoy perfect dispensing with calibrated portion control.

- New slim/narrow design uses less prep table space
- Capacity: 0.91 kg above refill line
- Provides improved portion control (0.70ml)
- Container Dimensions: 165 x 89mm Overall Height: 232mm Weight 1.40 Kg
- Includes cover with tether attachment to reduce loss
- Easy calibration – no tools required

All internal parts are colored white or red, providing easy identification when mixed with mustard dispenser parts. Some assembly required.

| CODE    | DESCRIPTION                       | \$  |
|---------|-----------------------------------|-----|
| 398-CN  | Mustard Dispenser Narrow          | 155 |
| 406-AN  | Sauce Dispenser Narrow            | 160 |
| 417-ANP | Dual Holder for 398-CN and 406-AN | 275 |



398-CN Narrow Mustard Dispenser SHOWN



417-ANP Dual Holder

## PRINCE CASTLE POUCH MATE

### 404-26

Use with any Pouch-Pak condiment.

Saves money by recovering previously wasted product

Simple to use

Stainless steel construction

LIST PRICE EA. **\$70**



## TOMATO SABER

Prince Castle's Tomato Saber is the world's leading tomato slicing system. The Perma-Tight® blade cartridge never requires blade tightening or adjusting. Blade replacement is fast and easy – simply snap the blade cartridge into position and the Saber is ready to use. A contoured pusher head holds the tomato in place for slicing, and permanently lubricated bearings ensure the slicing stroke is smooth and quick. The exclusive tomato catcher snaps onto the unit and catches the sliced tomato for easy handling.

Overall dimensions: 465W x 216D x 238Hmm

Weight: 6.4Kg.

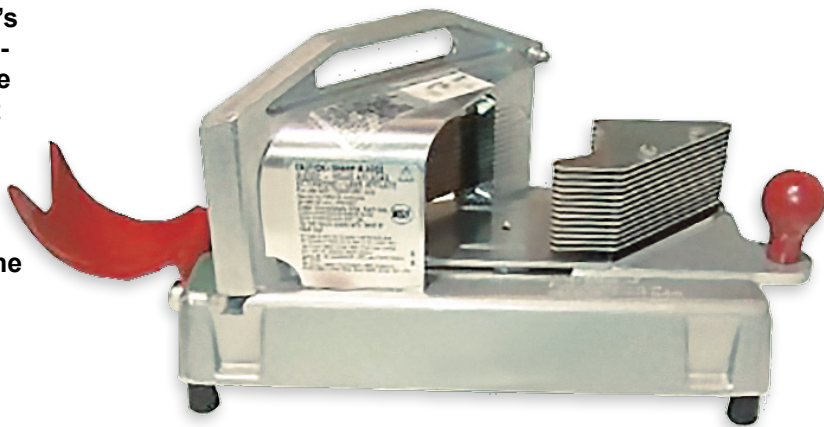

| CODE  | DESCRIPTION                          | \$   |
|-------|--------------------------------------|------|
| 943-A | Tomato Saber 4.7mm Slice (12 blades) | 1750 |
| 943-B | Tomato Saber 6.3 mm Slice (9 blades) | 1395 |

| SABER MODEL | CUT SIZE/ No of blades | PART CODE |
|-------------|------------------------|-----------|
| 943-A       | 4.7mm, 12 blade        | 943-038A  |
| 943-B       | 6.3mm, 9 blade         | 943-039A  |

Replacement Blades can be purchased individually from our Spares/Parts Department, see chart.

## TOMATO CORE-IT

The fastest, safest way to easily core the tomato prior to slicing/dicing/cutting. Available singly or in bulk.

| CODE  | DESCRIPTION            | \$  |
|-------|------------------------|-----|
| 953   | TOMATO CORE IT         | 12  |
| 950-1 | Bulk Pack (Box of 144) | 777 |



## WEDGE WITCH

Citrus wedge slicers for the busiest bar/kitchen. Rugged blade construction and simple to use, with the choice of the heavy duty 908 model or the economical CW-6 (Yellow body) for smaller operations.

| MODEL  | DESCRIPTION                                   | \$   |
|--------|---|------|
| 908-A8 | WEDGE WITCH ( 8 SECTION) ALL METAL            | 1400 |
| CW-6   | CITRUS SABER (8 SECTION) YELLOW POLYCARBONATE | 330  |



## DICE WITCH

The answer to heavy duty dicing, with sturdy frame, precision pusher head and cutter assembly.

| MODEL | DESCRIPTION                         | \$   |
|-------|-------------------------------------|------|
| 910-A | Dice Witch 3/8" (9.53mm) Square Cut | 1350 |



## PRINCE CASTLE GRILL BRUSHES & MAINTENANCE TOOLS

Essential equipment for every venue involved in heavy grilling/char grilling. These heavy duty brushes are available in Medium or Coarse grade to suit most grills.

| CODE | DESCRIPTION         | \$  |
|------|---------------------|-----|
| CC   | Char-Brush (coarse) | 175 |
| CM   | Char-Brush (medium) | 190 |



Replacement brush heads (6 / Box) can be purchased individually from our Spares/Parts Department and come with replacement screws (see chart).

| BRUSH MODEL | REPLACEMENT HEAD |
|-------------|------------------|
| CC          | CC-1             |
| CM          | CM-1             |

## REDI-GRILL GRILL MAINTENANCE TOOLS

Maintain food standards and quality with these professional grill tools. The heavy duty 161 Scraper makes light work of grill plate maintenance.

| CODE | DESCRIPTION        | \$  |
|------|--------------------|-----|
| 161  | Redi-Grill Scraper | 210 |



Replacement Scraper Blades can be purchased from our Spares/Parts Department (see chart).

| SCRAPER BLADE CODE | DESCRIPTION      |
|--------------------|------------------|
| 161-HD             | Heavy Duty       |
| 161-6DP            | Disposable (Pk6) |

Quick cleanup of the grill plate surface during the day is made easy with this made-for-purpose heavy duty grill plate wiper.

| CODE    | DESCRIPTION | \$  |
|---------|-------------|-----|
| 233-71A | Grill wiper | 250 |



Replacement Wiper Blades can be purchased from our Spares/Parts Department (see chart).

| WIPER MODEL | REPLACEMENT WIPER |
|-------------|-------------------|
| 233-71A     | 233-86C (Pk4)     |

## BUTTER SPREADER/MELTING PAN

**50**

Dress Up Butter Spreader

LIST PRICE EA. **\$380**



## MOP & BROOM STATIONS

**918-B**

Mop and Broom Station  
450mm long

LIST PRICE EA. **\$275**



## FRY SCOOPS

**252-DH**

Sturdy Dual Handle Fry Scoop.

LIST PRICE EA. **\$116**





# PROLUXE™



## Double Your Output

Easily grill two separate menu items or double the output of a single entree.



COMPACT SIZE



HIGH PRODUCTION



EVEN HEAT DISTRIBUTION TECHNOLOGY



GRILL IN SECONDS



EMBEDDED HEATING ELEMENT

## Small Footprint, High Output

This compact split lid grill is the perfect machine to grill and seal quesadillas, sandwiches, burritos and more. Our exclusive manufacturing process casts the heating elements into the platen resulting in more even heat distribution and longer life expectancy. Backed with an exclusive heating element limited lifetime warranty.

| MODEL                    | SL1266               |
|--------------------------|----------------------|
| TEMP CONTROL             | Yes                  |
| NET WEIGHT               | 30kgs                |
| DIMENSIONS               | 420W X 550H X 480Dmm |
| WATTS                    | 1900                 |
| SUPPLIED WITH 10AMP PLUG | Yes                  |
| MAX HEAT                 | 274°C                |
| LIST PRICE               | 6990                 |



San Jamar have been the innovators in quality solutions for food safety, counter service and washroom products- innovation driven by real world experience directly gained from its customers. Products that are used throughout the world that make dispensing, food handling, transportation, safety and sanitation so vital to successful food and venue management. With an ever increasing product range, San Jamar offer a high quality, reliable answer to the many needs in any establishment.

## EZ-FIT CUP & LID DISPENSERS

**HOLDS A SLEEVE OF CUPS**

The most versatile and popular cup dispenser to accommodate cup sizes from 73-121mm diameter, with easy to change rubber gaskets. Easy to install, reliable and ideal for venues dispensing different size cups, or where the cup size requirements may change over time.

Comes with pack of 4 different size black gaskets (S, M, L, XL) and chrome finish ring.

### **C2410CBKFSM** EZ-Fit One-Size-Fits-All Counter Mount CUP Dispenser

Metal finish trim ring, supplied with 4 pre-cut gaskets. Suits Rim Diameters: 73-121 mm  
Tube Length: 597 mm, 146mm counter hole diameter.

[Companion Lid dispensers available](#)

**LIST PRICE EA. \$189**



### **L2400CFSM** Ez-Fit In-Counter LID Dispenser

(Companion to C2410 model dispensers)

Suits 95-115mm diameter lids, with "metal finish" trim ring.  
Tube length: 603mm. 146mm counter hole diameter.

**LIST PRICE EA. \$235**

Recommended  
for Horizontal  
mounting.



### **C2210CBKFSM** EZ-Fit One-Size-Fits-All Counter Mount CUP Dispenser

Metal finish trim ring, supplied with 4 pre-cut gaskets. Suits Rim Diameters:73-98 mm  
Tube Length: 590 mm, 124mm counter hole diameter.

[Companion Lid dispensers available](#)

**LIST PRICE EA. \$178**



### **L2200CFSM** Ez-Fit In-Counter LID Dispenser

(Companion to C2210 model dispensers)

Suits 70-95mm diameter lids, with "metal finish" trim ring.  
Tube length: 603mm. 124mm counter hole diameter.

**LIST PRICE EA. \$235**

Recommended  
for Horizontal  
mounting.



### **C2410SM** Surface Mount CUP Dispenser

One-Size-Fits-All EZ-Fit model for installations where counter mounting is impractical, comes with sturdy wire frame for mounting.

Rim Diameter 73-121 mm. Tube Length 597 mm.

Supplied with 4 pre-cut gaskets.

**LIST PRICE EA. \$400**





## COUNTER MOUNT ADJUSTABLE COLLAR CUP DISPENSERS

C Series Counter Mount dispensers come with adjustable collars to accommodate a specific range of cup sizes. Durable stainless steel construction and available in Vertical, Horizontal or Foam cup models to suit demanding installations. Many busy fast food outlets enjoy the reliability of these models.

### C3400 SERIES

**FOR CUP RIM DIAMETERS 70-98MM**  
(Tube length 597mm, Counter hole dia. 119mm)

| CODE    | MOUNT      | CUP TYPE      | \$  |
|---------|------------|---------------|-----|
| C3400CH | Horizontal | Paper/plastic | 175 |



### C3500 SERIES

**FOR CUP RIM DIAMETERS 101-123MM**  
(Tube length 597mm, Counter hole dia. 146mm)

| CODE    | MOUNT      | CUP TYPE      | \$  |
|---------|------------|---------------|-----|
| C3500CH | Horizontal | Paper/plastic | 230 |

## EZ-FIT HOT LID DISPENSER

**Space-efficient:**

The in-counter mount can be oriented horizontally or vertically, keeping countertops organised

**Sanitary:**

Its one-at-a-time rubber dispensing gaskets safeguard lids from contamination

**User-friendly:**

Compatible with a variety of lid shapes and sizes

**Operational efficiency:**

Reduces lid waste and eliminates messy stacks

**Versatile Design:**

Interchangeable rubber gaskets can fit a wide variety of lids

| CODE  | DESCRIPTION               | SUITS RIM SIZE | \$  |
|-------|---------------------------|----------------|-----|
| L2210 | Hot Lid Dispenser - Small | 76-95mm        | 180 |
| L2410 | Hot Lid Dispenser - Large | 95-101mm       | 180 |







## WALL MOUNT PULL TYPE FOAM CUP DISPENSERS

### UNBREAKABLE POLYETHYLENE

San Jamar Foam Cup Dispensers in economical and unbreakable Polyethylene construction with an easy to install wall mount 'slide-on' system, in two sizes to suit a wide range of Foam Cups.



| MODEL     | CUP SIZE   | RIM DIA. | \$  |
|-----------|------------|----------|-----|
| C4210PFSD | 120-300 ml | 70-85 mm | 110 |
| C4410PFSD | 350-710 ml | 82-98 mm | 100 |

\*\*\*While stocks last



### STAINLESS STEEL

San Jamar Foam Cup Dispensers in Stainless Steel construction with an easy to install wall mount 'slide-on' system, in three sizes to suit a wide range of Foam Cups.

| MODEL   | CUP SIZE    | RIM DIA.  | \$  |
|---------|-------------|-----------|-----|
| C4200PF | 120-300 m   | 70-85 mm  | 165 |
| C4400PF | 350-710 ml  | 82-98 mm  | 180 |
| C4500PF | 950-1360 ml | 98-123 mm | 235 |

\*\*\*While stocks last

## WALL MOUNT PULL TYPE STAINLESS STEEL CUP DISPENSERS

San Jamar's stainless steel dispensers offer the high-end image that only stainless steel can provide, with the utmost durability. Our pull-type cup dispensers have San Jamar's patented, time-tested design for dependable one-at-a-time dispensing. These dispensers include 'slide-on' wall mount brackets. Suitable for plastic and paper.



| MODEL  | CUP SIZE    | RIM DIA.   | \$  |
|--------|-------------|------------|-----|
| C3200P | 180-300 ml  | 50-80 mm   | 170 |
| C3400P | 350-710 ml  | 70-98 mm   | 180 |
| C3500P | 950-1360 ml | 101-123 mm | 245 |



## WIREWORCS CUP DISPENSER & LID ORGANISER

Cost effective option for dispensing paper, plastic or foam cups one-at-a-time. Coils adjust to fit cups ranging from 3 to 4.5mm rim diameter. Comes with side panels to prevent contamination.

| CODE     | DESCRIPTION  | \$  |
|----------|--|-----|
| C8503WF  | 2 Cup dispensers, 1 lid organizer, NO side panels. <b>NEW CODE</b> | 400 |
| C8504WFD | 3 Cup dispensers, 1 lid organizer, 2 side panels.                  | 800 |

### ACCESSORIES

| CODE    | DESCRIPTION   | \$ |
|---------|---|----|
| C8500S  | Optional straw caddy to suit both of the above models, sold separately. | 45 |
| X101987 | Optional spindle to suit both above models, <b>PACK OF 2.</b>           | 54 |

C8503WF model



C8504WFD shown with optional Straw Caddy and spindles





## LID DISPENSERS

### L1014 - Counter or Wall Mounted Lid Organiser

Each compartment is adjustable to adapt to the lid size. Anti-slip feet ensure that unit will stay in place during counter-top use. Dimensions 165H x 362W x 133D

**LIST PRICE EA.            \$295**



### PCL3ADJ - Adjustable Portion Cup & Lid Organiser

2"-3" adjustable

Multi-channel adjustable design stores disposable portion cups and lids neatly in each unit

Provides easy access and quick refilling of lids in high-traffic environments

Faceplate can be switched out to accommodate different napkin styles

Allows smooth one-at-a time dispensing down to the last napkin- even when overfilled

Easy-to-clean clear plastic resists cracking and breaking for extended use

Dimensions: 304H x 109W x 260Dmm

**LIST PRICE EA.            \$95**



## DIGITAL SCALES

### SCDG33WD Digital Scale

Waterproof – IP67 rated scale can be completely submerged for quick cleaning and sanitizing

Rechargeable Battery – Lasts up to 64 hours on a single charge eliminating the hassles of cords and dead batteries

Easy Read Display – Large screen features imperial (lb / oz) and metric (kg / g) units of measure for precise portioning

Convenient Taring – Quickly reset the scale to zero weight to measure multiple items in a single container

1g increments, 15kg capacity. Dimensions: 28L x25W x12Hcm 2kg

**LIST PRICE EA.            \$710**





## NAPKIN and STRAW DISPENSERS

### H5003TBK COUNTER-TOP NAPKIN DISPENSER

San Jamar's Venue® line of napkin dispensers offer optimal dispensing for a variety of interfold napkin sizes.

Dispenser holds up to 550 interfold napkins reducing the need for frequent refilling  
Designed for storage convenience and high-volume dispensing in tight spaces  
Faceplate can be switched out to accommodate different napkin styles  
Allows smooth one-at-a time dispensing down to the last napkin- even when overfilled  
Easy-to-clean clear plastic resists cracking and breaking for extended use  
Dimensions: 184H x 209W x 413Dmm

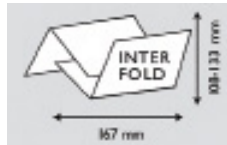

**LIST PRICE EA.            \$195**

### H5000STBK COUNTER-TOP with Stand NAPKIN DISPENSER

San Jamar's Venue® Napkin Dispenser with Stand is an ideal choice for full-fold countertop napkin dispensing. The Venue® Napkin dispenser provides smooth, precise dispensing—even at maximum capacity. The stand feature enhances image and offers high-volume dispensing in tight spaces.

Patented one-at-a-time dispensing reduces napkin waste  
33% more capacity than competing mini-fold and full-fold dispensers  
Stand model enhances image and saves counter space  
Smooth dispensing down to the last napkin  
Impact-resistant plastic construction  
Dimensions: 441H x 203W x 330Dmm

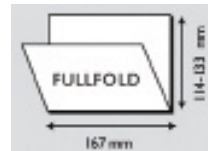

**LIST PRICE EA.            \$215**

### L320C

Organises straws or stirrers utilising a simple adjustable mounting ring to lock and secure the holder. Also doubles as a trash chute with removable bottom plate. Diameter: 136mm Tube Length: 152mm.

Counter hole diameter 106mm.

**LIST PRICE EA.            \$148**



**ALSO AVAILABLE (not illustrated) L360C Large Trash Chute 168mm Diameter \$108**





**PUMP SYSTEMS / BAR SUPPLIES / SAFETY WRAP**

**FRONTLINE PUMP SYSTEMS**

Perfect for self-service areas where portion control is critical.

**Ultra pumps dispense in 1 x 28.34g portions.**

2.36 litre jars are removable for easy cleaning and refilling.



**CONDIMENT PUMP SERVICE CENTRES**

| MODEL | WELLS/PUMPS         | \$   |
|-------|---------------------|------|
| P9712 | 2 well with 2 pumps | 745  |
| P9713 | 3 well with 3 pumps | 940  |
| P9715 | 5 well with 5 pumps | 1530 |

**THE DOME GARNISH CENTRE**

**BD4006S**

The domed lid rotates back for easy access and increased capacity when closed.

Uses six standard size trays supplied to keep food chilled (or optional deep trays for extra capacity).

Complete unit is slanted towards the operator for convenience

Integrated snap-on caddies store straws, stirrers and picks.

Dimensions:

590mmW x 180mmH x 130mmD with Caddies

520mmW x 180mmH x 130mmD without Caddies

**LIST PRICE EA.            \$210**



BD4006S shown with caddies installed

**THE MINI DOME GARNISH CENTRE**

**BD2002**

Connectors provide modularity between Mini Dome, Dome and snap-on caddies.

**LIST PRICE EA.            \$110**



**SAF-T-WRAP DISPENSER**

Makes proper food rotation faster and easier by combining wrapping and date labelling tools in one convenient location.

Saf-T-Wrap® Station holds film or foil, dating labels and includes storage areas for box cutters, pens and markers. Safer and more sanitary than dirty film and foil boxes, Saf-T-Wrap® Station's commercial-grade suction cup feet hold securely to countertops during use, minimising cut injuries.

**SW1218SC**

Saves money by reducing labelling time and minimizing food waste by aiding in FIFO food rotation.

Dispenses dating labels in multiple sizes and configurations.

Comes with slider safety blade for film, foil and paper.

**LIST PRICE EA.            \$330**





## ICE HANDLING SOLUTIONS

### SI9000 - SAF-T-SCOOP & GUARDIAN

Ergonomic handle, contamination shield, tapered chute, sanitary storage caddy, easy to clean.

LIST PRICE EA.      \$295



### SI6000 - SAF-T-ICE TOTE

Ergonomic handle, drying and storage hook, clear identification

LIST PRICE EA.      \$190



### SILD6000 - LIGHT DUTY ICE TOTE

Ergonomic design, integrated hanger, recessed bottom, clear identification. 22L

LIST PRICE EA.      \$105



### IC222003 - Cateraide™ Ice Caddy

90kg ice capacity, 2 fixed and 2 swivel castors 1 with brake.  
Dimensions including handle 781L x 559W x 927Hmm

LIST PRICE EA.      \$2100

## OVEN MITTS

### 810CM15 - BESTGRIP CONVENTIONAL OVEN MITT

Heat protection up to 260°C, non-slip grip, integrated storage, easy to clean, ambidextrous design. Single mitt.

LIST PRICE EA.      \$60



### 800FG17-BK - OVEN MITT BESTGUARD

Heat protection up to 230°C, Kevlar stitching, angled cuff, non-stick coating, ambidextrous design. Pair of mitts.

LIST PRICE EA.      \$50



### 811TG15 - OVEN MITT TEFLON

Heat protection up to 230°C, hanging loop, non-stick coating, ambidextrous design. Pair of mitts.

LIST PRICE EA.      \$30





## KLEEN-PAIL®

Kleen-Pail's meet HACCP dedicated use guidelines for cleaning and sanitising cloths used to wipe down surface areas. Kleen-Pails make it easy to separate containers used for food storage from those used for dangerous non-food purposes. They also eliminate potential confusion between cleaning and sanitising solution containers. Green Kleen-Pails are used for soap solutions and Red Kleen-Pails are used for sanitising solutions.

**KPP256RD** 7.5L Kleen-Pail® **RED**  
**KPP256GN** 7.5L Kleen-Pail® **GREEN**  
 LIST PRICE EA.           **\$30**

**KPP196RD** 5.6L Kleen-Pail® **RED**  
**KPP196GN** 5.6L Kleen-Pail® **GREEN**  
 LIST PRICE EA.           **\$22**

Each unit comes with volume indicators on the inside of the pail.



## ALLERGEN SAFE-T-ZONE SYSTEM

### ASZ121812SYS

Protects guests with food allergies  
 Special purple colour to alert all kitchen staff  
 Handy case includes Saf-T-Grip 305x457mm cutting board, tongs, turner and chef's knife.  
 Board and tools dishwasher safe  
 Works to avoid allergen cross-contact/contamination  
 Optional waterproof thermometer available (code ASZTHERMW)

LIST PRICE EA.           **\$440**



ASZTHERMW Optional professional thermometer (waterproof and dishwasher safe) POA





## DOCKET HOLDERS / SLIDE CHECK RAILS

Anodised Aluminium Docket Holders provide an easy-to-use system for check orders. Unique design allows for one handed check placement.

Aluminium slide check racks available in various lengths.

Glass marbles hold checks in place and will not melt even under the hottest of kitchen temperatures.



| MODEL   | CONSTRUCTION                 | LENGTH  | \$  |
|---------|------------------------------|---------|-----|
| CK6518A | Slide Check Rack – Aluminium | 460 mm  | 50  |
| CK6524A | Slide Check Rack – Aluminium | 610 mm  | 68  |
| CK6536A | Slide Check Rack – Aluminium | 915 mm  | 90  |
| CK6548A | Slide Check Rack – Aluminium | 1220 mm | 115 |

## HAND WASHING STATION COMBO - Hands Free & manual models

These Hand Washing Station Combo packs are the economical solution that ensures all the tools needed for employees to properly wash their hands are readily available. Controls towel usage per user and has completely hands free operation with the T1440TBK model with long-lasting battery power and manual override feature. Place these units wherever required to comply with regulations without the need for an electrician.

### T1440TBK (Automatic Hands free)

Smart System **Touchless** battery powered towel dispenser dispenses any quality of paper automatically with sensors, easy to use and reduces wastage. Adjustable length & interval time.

Touchless Soap Dispenser battery-powered (up to 80,000 cycles/6 months) Dispense a wide variety of liquid, soaps, sanitisers (except pumice). Unique hybrid manual pump override when batteries run low Hand washing chart gives step-by-step instructions for proper hand washing.

**LIST PRICE EA. \$790** \*\*\*While stocks last



Available in Black only.

### T1430TBL (Touchless Towel Dispenser)

- ▶ Smart System Touchless battery powered towel dispenser Dispenses any quality of paper automatically with sensors, easy to use and reduces wastage.
- ▶ Bulk soap dispenser will dispense a wide variety of liquid and lotion, soaps (except pumice).
- ▶ Hand washing chart gives step-by-step instructions for proper hand washing.

**LIST PRICE EA. \$640** \*\*\*While stocks last



Soap dispenser above available in Arctic Blue to match towel dispenser. Please advise when ordering.

| MODEL                    | SKFDI                |
|--------------------------|----------------------|
| REFRIGERANT              | R290                 |
| WEIGHT                   | 35kgs                |
| DIMENSIONS               | 454W X 454D X 671Hmm |
| POWER                    | 240V                 |
| SUPPLIED WITH 10AMP PLUG | Yes                  |
| TEMP RANGE               | -20.6 TO -15°C       |
| LIST PRICE               | 6995                 |



## Features

### Eco-Friendly Refrigerant

R290 refrigerant with a global warming potential (GWP) of 3

### Easy to Clean

Stainless steel interior with coved corners, finished edges, and removable lids

### High-Density Insulation

Foamed-in-place, CFC-free polyurethane insulation for maximum strength, rigidity, and insulation

### Cold Wall Refrigeration System

Optimized temperature control thanks to the cold wall refrigeration and top access

### Heavy-Duty Construction

Stainless steel exterior plus galvanized lower cabinet and base reduce the risk of corrosion

### Folding Hinged Lid

Insulated, front and back hinged lid for easy top access

### Cabinet Capacity

Maximized interior storage area of 0.96ft<sup>3</sup>

### Integrated Design

Fitted flange design ensures the fit within any countertop

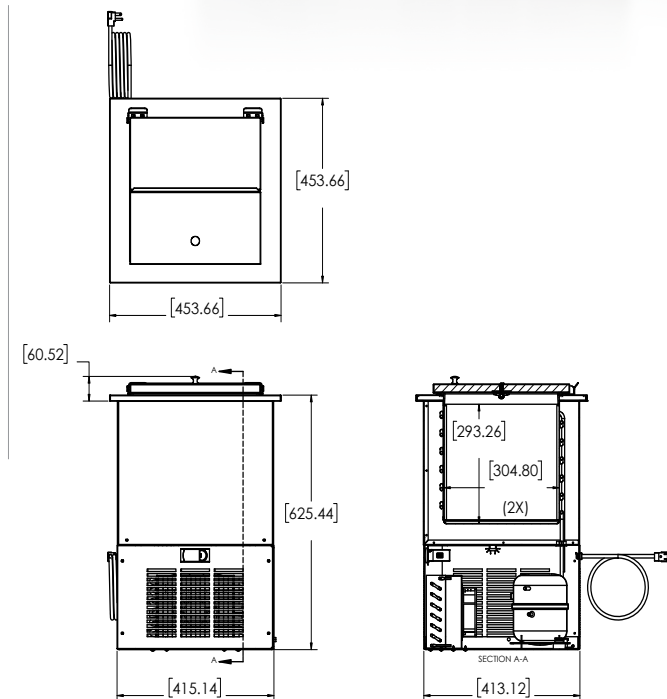

| MODEL       | K30-1010  |
|-------------|---|
| DESCRIPTION | Dipperwell Assembly:<br>Stainless Steel Dipperwell complete with inner and outer shell, Stainless Steel drain, highly polished chrome plated faucet, chrome plated brass tailpiece. Suits 150mm cutout. |
| LIST PRICE  | 450   |

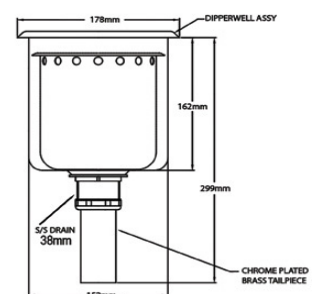

## WINE Coolers

# BUTLER SERIES

The Butler Series offers cost effective options for small, medium and large wine and beverage collections. Dual-pane, all-glass doors with black trim and stainless steel accents characterize these modern style fridges.



## 48-Bottle Single-Zone Wine Cooler

- Flexible free standing design can be used in almost any room
- Exterior touch screen controls with LED display
- Set and monitor temperature between 39-65 °F (4-18 °C)
- Interior light illuminates bottles
- Insulated dual pane tinted glass door locks in the cold
- Sturdy scalloped wire shelves extend 20%
- Capacity: approx. 48 standard 750ml wine bottles



Wire Racks

EL-48TS

Certifications:



\*Note: Bottle capacity based on standard Bordeaux style bottle approximately 11.5" x 2.9" dia.

| PRODUCT NAME                      | COLOR | SKU     | UPC          | DIMS (mm W x D x H) | PRICE |
|-----------------------------------|-------|---------|--------------|---------------------|-------|
| 48-Bottle Single-Zone Wine Cooler | Blk   | EL-48TS | 657433008471 | 541W x 545D x 830H  | 1095  |





## 155-Bottle Dual-Zone Wine Cooler

EL-142SDST

- Extra-large capacity built in or free standing wine cooler; great for kitchens, wet bars or pantrys
- Incorporates inverter technology to reduce energy consumption by up to 20%
- Insulated dual pane glass door with stainless steel frame and matching handle
- Stores up to 78 bottles in the lower compartment and up to 77 bottles in the upper compartment; top shelf is removeable to store larger bottles
- Temperature range: upper zone (40-55 °F) / lower zone (55-72 °F)
- Stainless steel trimmed shelves extend 40%
- Interior LED light illuminates bottles
- Security lock



Metal Shelves with Stainless Lip

### Certifications:



| PRODUCT NAME                     | COLOR      | SKU        | UPC          | DIMS (mm W x D x H) | PRICE |
|----------------------------------|------------|------------|--------------|---------------------|-------|
| 155-Bottle Dual-Zone Wine Cooler | Stnlss Stl | EL-142SDST | 657433015103 | 600W x 680D x 1860H | 3930  |



## 184-Bottle French Door Wine Cooler

EL-36TD180

- Extra-large capacity built in or free standing wine cooler; great for kitchens, wet bars or pantrys
- Two separate and independently controlled temperature zones
- Insulated dual pane frameless glass door with exterior touch screen controls
- Stores up to 92 bottles in each zone
- Temperature range: left zone (39-65 °F) / right zone (39-65 °F)
- Blackwood trimmed shelves extend 40%
- Interior LED light illuminates bottles
- Security lock
- Capacity: approx. 184 standard 750ml wine bottles



Gliding Shelves with Wood Lip

### Certifications:



| PRODUCT NAME                       | COLOR | SKU        | UPC          | DIMS (mm W x D x H) | PRICE |
|------------------------------------|-------|------------|--------------|---------------------|-------|
| 184-Bottle French Door Wine Cooler | Blk   | EL-36TD180 | 657433015752 | 886W x 630D x 1765H | 5120  |

Butler Series WINE COOLERS

## WINE Coolers

# BUTLER SERIES

### 98 Bottle/200 Can Dual-Zone Wine & Beverage Center

#### EL-100WBC-TS

Vinotemp's Dual-Zone Wine & Beverage Center brings an element of class and elegance to any room. This premium wine & beverage cooler will allow you to store your collection in the optimal conditions so that your wine and beverages can be kept at respective temperatures. An easy-to-use digital control panel with LED readout allows you to set the individual cooling zones at two different temperatures to ensure that your wine bottles and beverage cans are maintained properly. This unit features two dual-paned glass doors with recessed handle that separate the wine storage in the upper zone and beverage storage in the lower zone. Outfitted with 7 Ouzo™ gliding wire racks with black lip and 4 tempered glass shelves, this wine & beverage cooler can hold approximately 98 bottles and 200 cans in two separate cooling zones. Frameless cabinet with all-glass technology and dual-paned glass doors give a stylish look to this cooler while providing you with easy access to your favorite wine and beverages. This attractive and modern wine & beverage cooler is designed to be a worthy home for all of your finest collections.



Beverage Compartment



Wine Compartment



Digital Control Panel



Blue LED Side Lights

### Features:

- Capacity: Holds approximately 98 bottles in the top section and 200 cans in the bottom section
- Dual-zone wine & beverage cooler
- Two-Door, Right-Hinge Unit
- Easy-to-use control panel with digital display
- Seven gliding Ouzo™ style wine racks with black wooden lip, a Vinotemp exclusive!\*
- Four tempered glass shelves
- Frameless black cabinet with seamless, all-glass technology and pole handles
- Front vent for built-in or freestanding installation
- Blue LED interior lights to best view your collection
- Wine storage on upper zone and beverage storage on lower zone
- Temperature Range:
  - Upper Zone (3.9-18.3°C) and Lower Zone (3.9-18.3°C)
- Dimensions: 608mm W x 680mm D x 1876mm H
- Net weight: 116kg.

| PRODUCT NAME                                       | COLOR | SKU          | UPC          | DIMS (mm W x D x H) | PRICE |
|--|-------|--------------|--------------|---------------------|-------|
| 98 Bottle/200 Can Dual Zone Wine & Beverage Centre | Blk   | EL-100WBC-TS | 657433015769 | 680W x 609D x 1877H | 4695  |



# WINE Coolers

# CONNOISSEUR SERIES

Smooth, seamless trim provides a framework for these beautiful fridges in a variety of made-for-each-other wine and beverage combos. A wood lip brings a touch of elegance to the cooler's strong lines and bold details. Low-E glass and a compressor cooling system help maintain the perfect temperature for your precious collection.



## 46-Bottle Dual-Zone Wine Cooler

EL-46WCST

- 24" inch design for built in undercouter application, can also be free standing;
- Two independently controlled temperature zones with through the door digital display
- Set temperature between 40 - 56 °F in upper zone, 54 - 65 °F in lower zone
- Blue LED interior display light
- Stores up to 16 wine bottles\* in the upper zone and 30 bottles of wine in lower zone; shelves extend 40%
- Stainless steel door frame with matching pro handle
- Insulated dual pane glass door locks in the cold
- Integrated door lock secures contents
- Right-hand swing



Grooved Shelves with Wood Lip

Perfect undercounter cooler for a medium-size wine collection

| PRODUCT NAME                        | COLOR      | SKU       | UPC          | DIMS (mm W x D x H) | PRICE |
|-------------------------------------|------------|-----------|--------------|---------------------|-------|
| 46-Bottle Dual-Zone Wine Cooler (R) | Stnlss Stl | EL-46WCST | 657433013857 | 595W x 595D x 875H  | 2490  |



# WINE Coolers

## Patented Backlit™ Panel

These showy units are all about creating a spectacular display for your best bottles. Streamlined patented stainless steel wine racks ensure that your bottles are properly secured while maximizing the visibility of wine bottle labels. Its patented interior Backlit™ panel has three different light-emitting diode (LED) options – **Heliotrope**, **Amber** and **Vinotemp BioBlu™** (which helps reduce the growth of bacteria and mold) – and can be selected at any given time or the interior lighting can be turned off.

Patented Interior Backlit™ Panel: (U.S. Patent No. D868,849 S)

Patented Label Forward, VinBo™ Racks: (U.S. Patent No. D910,089 S)



EL-54BCCOMM-L  
Special order item



EL-54COMM  
Special order item



### 188-Bottle Single-Zone Wine Cooler (Right Hinge)

EL-300COMM

- 30" inch commercial design for built in application, can also be free standing
- Digital controls with through-the-door LED display
- Set temperature between 41-64°F
- Patented Backlit™ display lighting has 3 light colors and casts a soft glow from the back of the unit
- VinBo™ secures the wine bottle horizontally with label visible, stores up to 141 bottles\* of wine Integrated door
- lock secures contents Shelves extend 90%
- Includes charcoal air filter
- Can be paired with the EL-300COMM-L



Heliotrope



Amber



Vinotemp BioBlu™

| PRODUCT NAME  | COLOR | SKU        | UPC          | DIMS (mm W x D x H) | PRICE |
|---|-------|------------|--------------|---------------------|-------|
| 188-Bottle Backlit™ Comm. 300 Single-Zone Wine Cooler | Blk   | EL-300COMM | 657433013611 | 750W x 689D x 1880  | 5995  |

WINE COOLERS Backlit™ Panel



**The VITO® Portable Oil Filter System is available in three capacities to suit your workload and fryer capacity. Simple to use drop-in unit - no need to drain oil from the fryer. VITO® is the ONLY simple to use pressure filtration system that removes contaminants down to 5 microns in size - more efficient than in-built filters, and VITO® can easily pay for itself inside twelve months. And it switches off automatically so you can get on with other work. Dishwasher safe designed and manufactured in Germany. Save up to 50% on your frying oil costs, improve your food quality and reduce your labour costs all at the same time. Add a VITO® FT 440 Oil Tester to determine exactly when to change the oil and save even more.**

## VITO® OIL FILTER SYSTEM

| CODE                          | VITO MODEL                           | FILTER TIME (Approx) | CAPACITY & DESCRIPTION  | WEIGHT | DIMS WHDmm      | \$   |
|-------------------------------|--------------------------------------|----------------------|---|--------|-----------------|------|
| 103404<br><i>(Was 101379)</i> | <b>VS Connect</b><br><i>(WAS 30)</i> | 4.5 mins approx.     | Suits fryers up to 12L litres volume. 300W (10Amp plug) Includes 10 Filters<br><i>Wifi model - VITOconnect</i>  | 6.3Kg  | 116 x 356 x 176 | 3265 |
| 103301<br><i>(Was 101380)</i> | <b>VM Connect</b><br><i>(WAS 50)</i> | 4.5 mins approx.     | Suits fryers up to 18 L litres volume. 300W (10Amp plug) Includes 10 Filters<br><i>Wifi model - VITOconnect</i> | 7.7Kg  | 116 x 400 x 191 | 4795 |
| 103204                        | <b>VL Connect</b>                    | 4.5 mins approx.     | Suits fryers 20L litres volume upwards. 500W (10Amp plug) Includes 10 Filters. Wifi model - VITOconnect         | 8.8kg  | 116 x 502 x 187 | 5880 |



VITO VS      VITO VM      VITO VL



Exclusive In-Fryer Filtering  
With Automatic Shut Off

**#VITOconnect**  
filter effectively, monitor smart



### Connect

Connect the VITO 80 with the local Wifi network in the kitchen.



### Serve

Configure the VITO easily with the mobile phone, tablet or PC. For example the filtration cycle time.



### Select

Usage data can be analyzed directly, for example: number of filtration cycles, total run time, date of the last filtration.



### View

Usage data can be viewed on different devices as well as via e-mail reports and the CRM system.



**VITO X cleans the oil and stores it in its tank. It provides an easy and hygienic transport in the kitchen. Because of its innovative vacuum-filtration technology, particles remain in the filter medium in a dry condition. Like every VITO oil filter system the X provides a microfiltration ensuring the optimal quality of your oil is preserved. The unique design makes sure the X can handle temperatures up to 200°C and provides highest safety at work, due to avoiding direct contact with hot oil. After filtration the oil can easily be pumped back into the fryer automatically.**

**Save up to 50% on your frying oil costs, improve your food quality and reduce your labour costs all at the same time.**

**Add a VITO® FT 440 Oil Tester to determine *exactly* when to change the oil and save even more.**

## VITO® X VACUUM FILTRATION SYSTEM

| CODE | DESCRIPTION   | WEIGHT | DIMS WHDmm       | \$    |
|------|---|--------|------------------|-------|
| XS   | Up to 35l/min filtration power and 40L tank (10amp)   | 45Kg   | 553 x 843 x 883  | 11290 |
| XM   | Up to 35l/min filtration power and 75L tank (10 amp)  | 56KG   | 553 x 1044 x 883 | 12280 |
| XL   | Up to 35l/min filtration power and 120L tank (10 amp) | 64Kg   | 553 x 1334 x 883 | 13650 |



### Additional Features

- **The VITO X can operate at frying temperatures**
- **Adjustable top handle**
- **Automatic off - Tank with built-in oillevel sensor**
- **Full stainless steel construction with cellulose filters (components used are food safe)**
- **Integrated heating for solid frying medium**
- **Big wheels with brakes**
- **Filter basket is dishwasher safe**
- **Easy off hose**





## VITO® T-SERIES TRANSPORT SYSTEM

| CODE | DESCRIPTION                        | WEIGHT | DIMS WHDmm       | \$    |
|------|------------------------------------|--------|------------------|-------|
| TS   | Transport pump   40L tank (10amp)  | 43Kg   | 555 x 843 x 723  | 7380  |
| TM   | Transport pump   75L tank (10amp)  | 56KG   | 553 x 1044 x 723 | 9850  |
| TL   | Transport pump   120L tank (10amp) | 64Kg   | 553 x 1334 x 723 | 10870 |

### Functionality:

VITO TS transports your used oil in an easy and fast way. It sucks the oil out of your fryer, and stores it inside its tank. From there, it can be safely transported on flat floors. The oil can then either be pumped back into the deep fryer, or simply disposed of.

### Features:

- ▲ Operating temperature up to 200°C
- ▲ Vacuum extraction
- ▲ Automatic off - VITO has built-in oil level sensor
- ▲ Automatic safety off - extraction/return 5min
- ▲ VITO made out of stainless steel
- ▲ Adjustable height of the handle
- ▲ Lockable castors
- ▲ Internal sieve to remove coarse debris

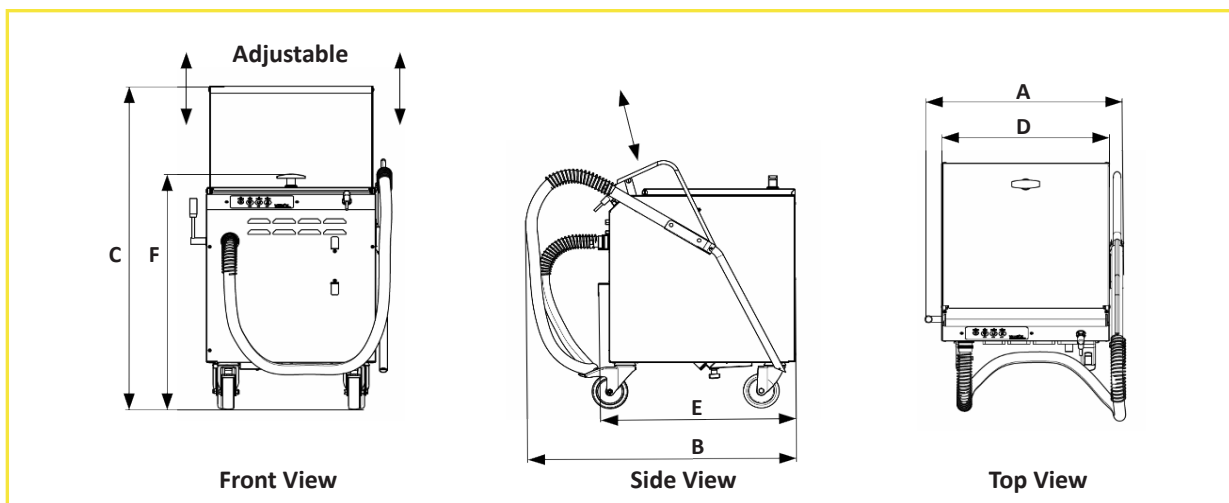



## VITO® OIL ACCESSORIES

### FT CONNECT BRIDGE OIL TESTER

FT CONNECT provides a fast, easy and reliable way to determine the quality of your frying oil. It measures the Total Polar Material (TPM) content and displays it as a percentage value. A three-colour alarm system simplifies the evaluation process by clearly indicating the oil's condition. Integrated with the VITOconnect platform, the FT CONNECT automatically creates an online HACCP list from your measured data via bluetooth. Bridge unit included.



LIST PRICE EA. **\$1665**



### 34022090 FRYER BOIL-OUT TABS

Powerful, safe and easy cleaning of commercial deep fryers and stainless steel fryer accessories.

Product description:

- removes burnt-in grease and oil
- intensive cleaner packed as tabs for effective cleaning of commercial deep fryers
- individually packed, simple dose
- fryer accessories made of stainless steel can be cleaned as well
- easy to use, saves working time

1 tin = 15 tabs

LIST PRICE EA. **\$120**

### FT 440 OIL TESTER

Food oil quality monitor and temperature measurement system, including probe, case & instructions. Easy to use "traffic light" warning system as well as digital display. Make sure you only change the oil when necessary and maintain perfect frying oil condition, whilst saving money.

LIST PRICE EA. **\$1290**



### VITO® REPLACEMENT CELLULOSE FILTERS

| CODE   | DESCRIPTION                         | \$  |
|--------|-------------------------------------|-----|
| 100112 | VS (WAS 30) FILTERS Box of 100      | 370 |
| 100114 | VM/VL(WAS 50/80) FILTERS Box of 100 | 485 |
| 101441 | FILTERS TO SUIT X SERIES Box of 50  | 475 |



**Yellow Brand Induction Units, one of the leaders in induction technology to the Australian market, now established and recognised as a highly efficient and safe cooking technology. Yellow Induction units are made to last and offer superior performance and quality compared to lesser units. And each Yellow Induction model comes with our exclusive 13 month warranty for absolute peace of mind when you next specify for that important project.**

## **YELLOW INDUCTION HOBS**

### **SINGLE PORTABLE COUNTER-TOP HOBS**

#### **ET-24M Counter Top Unit**

Powerful portable table top unit plug-in self contained for use in kitchen / buffets. Touch Panel, LED Display, 9 power setting, Temperature Holding, Timer, Smart Fan.

Dimensions: 295W x 425D x 84Hmm

Ceramic glass dimension: 294 x 275

2300 watts. 10 amp plug.

**LIST PRICE EA.      \$1820**



#### **ET-35M Counter Top Unit**

High Power portable table top unit plug-in self contained for use in kitchen / buffets. Touch Panel, LED Display, 9 power setting, Temperature Holding, Timer, Smart Fan.

Dimensions: 295W x 425D x 84Hmm

Ceramic glass dimension: 294 x 275

3400 watts. 15 amp plug.

**LIST PRICE EA.      \$2050**



#### **Y3500TT Counter Top Unit - whilst stocks last**

High Power portable table top unit plug-in self contained for use in kitchen / buffets.

Dimensions: 385 x 520 x 177mm

Ceramic glass dimension: 300 x 300 x 6mm (thick).

3500 watts. 15 amp plug.

**LIST PRICE EA.      \$2870**



#### **Y1000WCS**

Free Standing Unit mounted in attractive chrome stand with on-board controls and rear chafer support.

Dimensions: 385 x 385 x 100mm

Ceramic glass dimension: 360 x 380 x 4mm (thick).

1000 watts. 10 amp plug.

**LIST PRICE EA.      \$1995**





All Yellow Induction units offer Automatic Safety Shut-Off, Material Compatibility and small object Detector, Overheating Protection Device and Automatic Resetting. All these In-built/drop-in induction units have the same cut-out and require ventilation for optimum performance. Consult your FSM representative for more information.

**SINGLE DROP-IN HOB UNITS**

**Y300 Fanless Induction Warmer**

300 watt drop-in buffet/warmer. Can daisy chain up to 4 units. No ventilation under required  
Dimensions: 380 x 360 x 91.2mm 300 watts. 10 amp plug.

LIST PRICE EA. **\$1290**

**Y300R Remote Controller**

LIST PRICE EA. **\$65**



**Y1000NT Drop In Unit**

Perfect drop-in unit for buffet warming.  
Dimensions: 360 x 380 x 100mm  
Ceramic glass dimension: 360 x 380 x 4mm (thick).  
Remote controller supplied with flex cord.  
1000 watts. 10 amp plug.

LIST PRICE EA. **\$1590**



**Y2000D Drop In Unit**

Powerful 2000 Watts of power in a drop-in unit, ideal for buffet/kitchen/holding with remote control.  
Dimensions: 360 x 380 x 100mm  
Ceramic glass dimension: 360 x 380 x 4mm (thick).  
Remote controller supplied with flex cord.  
2000 watts. 10 amp plug.

LIST PRICE EA. **\$1795**



**Y2500AD Drop In Unit**

High output 2500W drop-in unit for kitchen or buffet use.  
Dimensions: 360 x 380 x 100mm  
Ceramic glass dimension: 360 x 380 x 4mm (thick).  
Remote controller supplied with flex cord.  
2500 watts. 15 amp plug.

LIST PRICE EA. **\$2095**



Yellow Induction built-in cooktops offer the rugged performance demanded of every commercial kitchen. Framed with stainless steel, these Dual Hob models have the capacity and versatility in one unit.

## BUILT-IN COOKTOPS

### Y3500DDSS

Built in Dual Hob Unit with remote controller for maximum performance and power, this dual unit offers versatility in a compact built-in unit.

Dimensions: 450 x 700 x 208mm

Comprises two 2 X 3500 watt cooking/warming surfaces.

Electrical: 7.2kw, 30 amp, Single phase. Unit supplied unplugged.

LIST PRICE EA.      **\$7950**



**2 x  
3500  
WATTS  
POWER**

## BOILING TABLE

### 2Y3500DDSSBT

Yellow induction boiling table. Includes 4 x 3.5kw induction hobs, built in controls to stainless steel bench.

Dimensions: 1100 x 900 x 900Hmm

Comprises two 2 X Y3500DDSS built in cooktops

Electrical: 14.4w, 2 x 30 amp, Single phase. Outlets required. Supplied with cord no plug

LIST PRICE EA.      **\$18850**



The new era of warming, **MULTI-ZONE** Induction technology that heats all points on the ceramic glass top. Newly developed technology can suit any shape and size of induction compatible display chafer, saucer, small utensils, pots and pans. Unlike normal Induction Units, these Yellow Multi-Zone units allow almost unlimited flexibility in pan size and placement and look fabulous in any setting.

## MULTI-ZONE BUFFET DROP IN INDUCTION

### YMC-2-2500

Versatile Multi Zone unit with two x 2500W units for warming/holding flexibility. Complete with remote generator rack and two (2) remote controller panels (as below).

Dimension: 800W x 380D x 66mmH

Ceramic Glass Dimension:

800W x 380D x 6mm (thick).

Supplied with 2 x 2500W generators with 15 amp plugs



Two Remote controller panels supplied

**5000  
WATTS  
POWER**



**LIST PRICE EA.      \$9475**

### YMC-3-2500

Versatile Multi Zone unit with three x 2500W units for warming/holding flexibility. Complete with remote generator rack and three (3) remote controller panels (as below).

Dimension: 1180W x 380D x 66mmH

Ceramic Glass Dimension:

1180W x 380D x 6mm (thick).

Supplied with 3 x 2500W generators with 15 amp plugs



Three Remote controller panels supplied

**7500  
WATTS  
POWER**



**LIST PRICE EA.      \$13350**

## REMOTE GENERATOR CONTROL & RACK (included with above)

Compact and remote type generator with easy access for maintenance and less interruption to daily operation. These units are supplied with the cooktops above and can be located within 3m of the cooking surface.

| MODEL      | DIMENSIONS             | CABLE LENGTH | TOTAL POWER    |
|------------|------------------------|--------------|----------------|
| YMC-2-2500 | 385W x 450D x 275mmH   | 3m*          | 5kw, 30 amp.   |
| YMC-3-2500 | 385W x 450D x 387.5mmH | 3m*          | 7.5kw, 45 amp. |

\*Max 3m remote cable between hob and generator.

Each Generator is supplied with its own 15A plug.

YMC-2-2500 = 2 power cords and 15A plugs.

YMC-3-2500 = 3 power cords and 15A plugs.

YMC-2-2500  
GENERATOR RACK  
SHOWN  
MOUNTED REMOTELY



All Multi-zone Induction generator units require adequate ventilation for maximum performance.



**YELLOW PLANETARY MIXER – NEW GEAR DRIVEN MODEL**

Offering commercial quality at an affordable price is the Model MY7 planetary mixer. With a wide range of accessories for flexibility and ease of use, including a wire whip, dough hook, flat beater, stainless bowl and integrated safety guard with unique dosing feeder. Plus the peace of mind of an Australia-wide 13 month parts and labour warranty.

**MY7 Commercial Planetary Mixer.**

- Gear Driven
- 0-11 precision speed adjustments for variable speed control
- Peacock blue coloured LED on controller
- User friendly head design for easier lift
- Very quiet operation
- Fully enclosed gear drive to reduce wear for longer life
- 304 food grade stainless steel accessories to ensure the food safety

**Specifications:**

- Rated Power: 35kW
- Bowl Volume: 7L
- Dimensions: 409D x 236W x 421Hmm
- Net Weight: 15kg
- Supplied corded with 10A cord and plug

**Accessories included:**

- Wire whipper
- Hook
- Beater
- Safety cover



\*STOCK DUE IN APPROX APRIL 2025

**LIST PRICE EA.           \$995**  
**6 BUY PRICE EA.       \$920**



## KITCHEN ACCESSORIES

### YT5607 Tomato Stem Corer

Remove the stems from your fresh, juicy tomatoes without fear of bruising by using this tomato stem corer! This convenient tool comes equipped with sharp teeth that quickly remove the stem from any ripe or unripe tomato, or even cucumbers and potatoes. It can also be used to craft wavy melon balls for added versatility.

Dishwasher safe | Stainless Steel | Dims: 160 x 29 x 26mm



| CODE     | DESCRIPTION              | \$  |
|----------|--------------------------|-----|
| YT5607-1 | Single Tomato Stem Corer | 14  |
| YT5607   | Box 12 Tomato Stem Corer | 156 |

### YT43 Rectangular Fry Basket

Rectangular Fry Basket with Orange Vinyl Handle. Prepare French fries, chicken fingers, onion rings, and other delicious fried foods with this fryer basket. Color-coded comfort grip vinyl handle keeps cool when in use and aids for easy identification during service. Hand wash only | Nickel plated mesh

Dims: Basket Size 160 x 300 x 130mm (Length 625 incl handle)



LIST PRICE EA.           **\$58**

### YT8 French Fry Scoop

Dual Handle Fry Scoop, Plastic. Serve up some delicious fries and keep your hands clean with this french fry scoop! Use for bagging up to-go orders or portion-controlled plating for dine-in customers. Ideal for use in the fast-paced environment of any kitchen. Dual handle.

Dishwasher safe | Polypropylene | Dims: 235 x 207 x 50mm



LIST PRICE EA.           **\$60**

## ELECTRIC CHARGRILLS

The Icarus Electric CharGrills have been engineered to replicate the intense heat of Woodfired and charcoal cooking. This high temperature, combined with the penetrating heat and true natural flames of the Icarus technology, not only gives the meat an amazing natural flavour but also tenderises meats in a way that traditional gas grills can't match, providing an unmatched grilling experience.

### 2 YEAR PARTS & LABOUR WARRANTY



#### Key Features :

**Heat Technology:** Proprietary Icarus Heat system reaches over 500°C for authentic chargrilled flavour, and penetrating heat.

**Refractory Floor:** Unique fat-vaporising system turns drippings into dust, for easy cleanup.

**Stainless Steel Resting Rack:** second-tier resting/grilling rack or optimal heat control and versatile cooking. Rest cooked or raw produce there to get to temperature.

**Temperature Control:** Adjustment for precision grilling, with an automatic element shutdown for safety.

**Control the Heat with the percentage dial.**

**Removable Components:** Easy-to-clean design with removable grilling racks and garnish rails

| MODEL    | DIMENSIONS WDH                                      | POWER                     | COOKING ZONES | LIST PRICE |
|----------|---|---------------------------|---------------|------------|
| IG600    | 600 X 730 (without garnish rail, 840 with) X 780mm  | 1 phase 240V 20amp 4.8kw  | Single        | 18320      |
| IG900    | 900 X 730 (without garnish rail, 840 with) X 780mm  | 2 phase 240V 20amp 9.6kw  | Dual          | 24760      |
| IG900PRO | 900 X 730 (without garnish rail, 840 with) X 780mm  | 3 phase 240V 20amp 14.4kw | Triple        | 28950      |
| IG1200   | 1200 x 730 (without garnish rail, 840 with) X 780mm | 3 phase 240V 20amp 14.4kw | Triple        | 32550      |

#### Accessories:

| MODEL    | DIMENSIONS WDH   | DESCRIPTION  | LIST PRICE |
|----------|------------------|--|------------|
| IGP300   | 300 X 485 X 85MM | DROP ON FLAT PLATE: a versatile accessory designed to enhance the cooking capability. Compatible with all models. Easy maintenance - simply lift off and clean | 1290       |
| IG600FS  |                  | FIXED STAND - to suit IG600  | 1700       |
| IG900FS  |                  | FIXED STAND - to suit IG900/PRO  | 1895       |
| IG1200FS |                  | FIXED STAND - to suit IG1200   | 2100       |
| IG600MS  |                  | MOBILE STAND - to suit IG600   | 1700       |
| IG900MS  |                  | MOBILE STAND - to suit IG900/PRO   | 1895       |
| IG1200MS |                  | MOBILE STAND - to suit IG1200  | 2100       |

